

Duolok[®]

Metric Tube Fittings



Tube Fittings 3-25mm

Company Information



1926 SSP Fittings Corp. is founded in Cleveland, Ohio, U.S.A. SSP begins as a contract manufacturer of screw machine products in brass and carbon steel to general industry.

1940s World War II shifts the company's focus to production of fittings for tubing, pipe, and hose. Following the war, SSP's customers are able to satisfy their own requirements without relying on outside companies for production. SSP contracts.



1970s New Focus. By the early 1970s, SSP embarks on a market & manufacturing driven strategy of producing quality fittings from difficult-to-machine alloys. The performance requirements of customers utilizing these materials in industries as diverse as marine, defense, offshore oil, and aerospace, drive SSP to establish both conformance quality standards, and service levels, which are significantly ahead of general industry at the time.

1980s The "Works". Things are really happening for SSP. The company establishes a product line and distribution channel for hydraulic fittings, which require significant investments in a new, state-of-the-art facility south of Cleveland. SSP builds a 165,000 sq. ft. facility to house our vertically-integrated "Works," including, by now, tool & die design & production, custom closed-die forging, machining, finishing operations, assembly and test. With over 200 work centers, SSP's Twinsburg "Works" is among the largest single-site facilities in the entire industry.



1990s Market Expansion. SSP's distribution network for high performance hydraulic fittings expands into some select global markets and new standards are required of US-based distributors to meet the growing competitive challenge. Investments in design engineering usher in the introduction of SSP Instrumentation and brands Duolok, Unilok, Griplok & TruFit instrumentation-quality tube & pipe fittings for process, research & power generation markets. Finally, as has now come to be expected, SSP is one of the first companies in our market to earn ISO 9001 certification.

2000 The New Force. SSP acquires Flolok Valve and enters the instrumentation valve marketplace. Significant investments in information technology & modern production equipment prepare the company to leverage its reputation for product availability & speed.



2004 Lean. SSP makes commitment to ourselves and our customers to launch a sustained implementation of Lean-Sigma as our primary operations strategy. Lean manufacturing - a business planning and execution system based on the Toyota Production System - is an excellent framework for extending SSP's historic advantage in speed and product availability.

2007 Continued Growth. Utilizing Kaizen methodology and Six Sigma tools, new products and capabilities are introduced at rapid rate. All manufacturing continues to be performed by SSP to keep replenishment times as quick as our growing customer base requires.



2008 100th Kaizen event completed. Factory floor transformation includes organization into Value Streams, widespread use of visual, real-time controls, emphasis on set-up reduction and 5S; utilizing Kanban pull based scheduling of A & B inventory items, and Design-for-Lean Sigma methodologies.

Swagelok® and Cajon® are registered trademarks of Swagelok Co.
Parker CPI® and Parker™ are registered trademarks of Parker Hannifin.
Hoke Gyrolok® and Hoke® are registered trademarks of Hoke Inc.
Duolok®, Unilok®, Griplok®, TruFit® & FloLok® are registered trademarks of SSP Fittings Corp.
Viton® and Teflon® are registered trademarks of E.I. duPont Nemours and Co.
Monei® is a registered trademark of Inco Alloys International

NOTICE: This publication is an uncontrolled copy of a controlled document. SSP has made every reasonable effort to insure the accuracy of the information contained in this publication, and is not to be held liable in any manner for any mistakes, omissions, typographical and/or printing errors.

How to Order Duolok Tube Fittings

Duolok brand tube fittings for metric tubing are ordered by specifying part numbers as listed in this catalog. The following explains the part numbering system:

Example: ISSDM4MC2

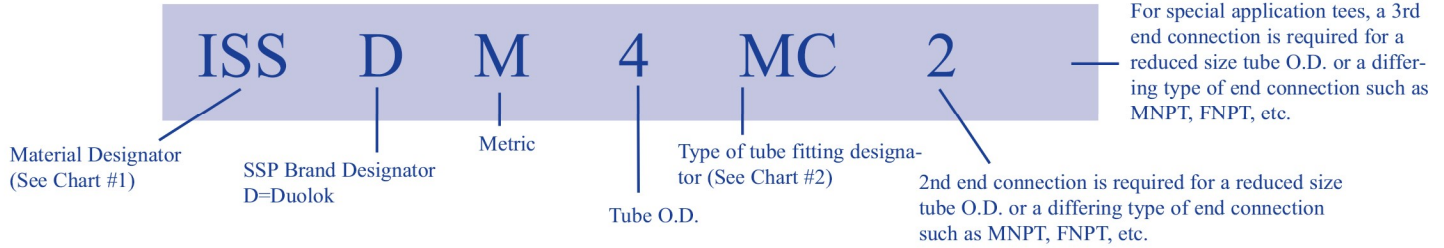

NOTES:

All Configurations: Only one size indicator is necessary when all of the connections are the same type and size.

Straights and Elbows: Specify the tube end first followed by the smaller tube end or differing type of connection (MNPT, FNPT, etc.)

Tees and Crosses: Tees are described by first sizing the run (1 to 2) and then the branch (3). Crosses are described by first sizing the run (1 to 2) and then the branch (3 to 4). See figure 1.

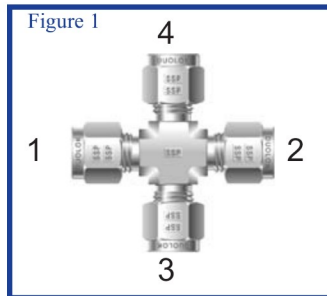

Specials: SSP manufactures a wide variety of special application tube fittings. Contact your local distributor for details regarding availability of special tube fitting configurations, materials and sizes.

CHART #1	
Materials Designator	Material
ISS	316 Stainless Steel

CHART #2	
Type of Fitting Designator	Description of Griplok Tube Fitting Types
BU	Bulkhead Union
CP	Cap
FA	Female Adapter
FBT	Female Branch Tee
FC	Female Connector
FCRT	Female Connector to ISO Tapered
FE	Female Elbow
FRT	Female Run Tee
MA	Male Adapter
MBT	Male Branch Tee
MC	Male Connector
MCRS	Male Connector to ISO Parallel
MCRT	Male Connector to ISO Tapered
ME	Male Elbow
MERT	Male Elbow to ISO Tapered
MERS	Male Elbow to ISO Parallel
MPWC	Male Pipe Weld Connector
MRT	Male Run Tee
P	Plug
PC	Port Connector
R	Reducer/Adapter
RPC	Reducing Port Connector
RU	Reducing Union
U	Union
UCS	Union Cross
UE	Union Elbow
UT	Union Tee
COMPONENTS	
BF	Back Ferrule
FF	Front Ferrule
FS	Ferrule Set
N	Nut
TI	Tube Insert

Identifying Metric Duolok Fittings

Duolok metric tube fittings have a stepped shoulder on the body hex and the nut, shaped fittings have a stepped shoulder on the nut.

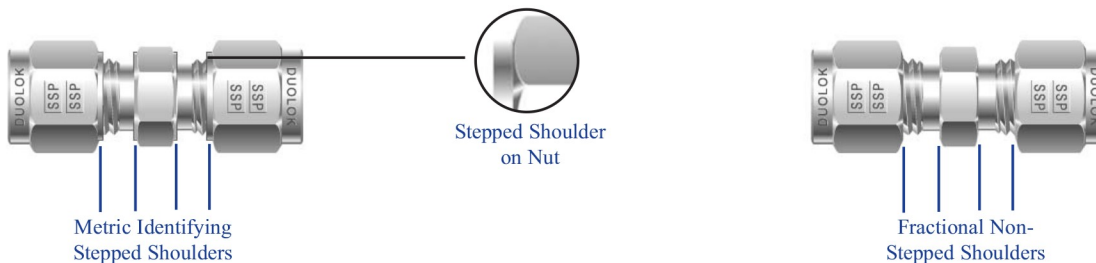

Duolok Tube Fittings

DESIGN

Duolok tube fittings are designed and manufactured to provide a reliable, leak-proof connection in instrument and process tubing systems. **Duolok** tube fittings consist of four precision-machined components:

- 1) Body
- 2) Front Ferrule
- 3) Back Ferrule
- 4) Nut

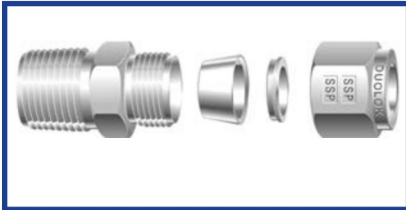

During make-up, the controlled drive action of the ferrules compensates for variations in tubing materials, hardness, and thickness of the tube wall to provide leak-tight connections in an extensive range of applications.

Additionally, in fulfillment of the design criteria, all **Duolok** components are manufactured with stringent tolerances and superior surface finishes to rigorous quality control standards to assure the optimum performance of each component.

OPERATION

Through critical interaction of precision-machined fitting components with the process tube, a leak-tight seal is achieved.

The simple geometric rotation of the **Duolok** nut provides the axial thrust necessary to "coin" the ferrules into the outside diameter of the tube. To eliminate any potential stress on an existing system, the tube fittings have been designed to not transmit installation torque from the tube fittings to the tube.

During the rotary movement of the nut, the internal surface of the nut meets with the rear surface of the rear ferrule to axially move the rear ferrule forward against the back radius of the front ferrule.

Simultaneously, the front ferrule is driven forward into the angular section of the fitting body to form a primary metal-to-metal seal. The back ferrule roll-in locking action occurs on the outside diameter of the tube to complete the sealing action and secure the tube within the fitting.

The controlled ferrule drive prevents body distortion and helps compensate for exposure to system variables such as vibration, pressure pulsation and thermal expansion or contraction.

QUALITY

SSP's Quality System has been certified to conform to the **ISO 9001:2000 Quality Standard**. Achievement of this prestigious status further confirms SSP's continuing commitment to quality which is reflected throughout the company in its personnel, policies, equipment, products and service.



In addition, all **Duolok** tube fittings are manufactured to the technical design specifications and rigid quality control standards of the SSP Instrumentation Division.

Statistical Process Control techniques are employed within the manufacturing process to assure timely, meaningful feedback to the production team. Attention to detail, through continual process monitoring and control, provides the necessary manufacturing quality for the **Duolok** instrumentation tube fittings.

PACKAGING

Duolok tube fittings are individually bagged to assure the highest levels of quality, safety and cleanliness. The protective bags eliminate contamination (tubing burrs, dirt, etc.) from entering the fitting prior to its use, and help to retain the integrity of the factory assembled body, nut, and ferrules.



As long as a **Duolok** tube fitting is in its original protective bag, it is identified as "factory new," completely assembled and ready for installation.

The individually bagged **Duolok** tube fittings are packaged in convenient, small-lot quantities for easy procurement and handling. Additionally, for efficient product identification and storage, the boxes are color-coded to the tube fittings' material of construction and have pictorial labels which include the part number, product description and box quantity.

Duolok Tube Fittings

MATERIALS

316 STAINLESS STEEL

Duolok straight configuration tube fittings are machined from type 316 stainless steel cold-finished bar stock in accordance with ASTM A-276 and ASTM A-479. Shaped bodies are machined from close-grained 316 stainless steel forgings in accordance with ASTM A-182. All 316 stainless steel **Duolok** components are heat code traceable with certified material test reports (CMTRs) available.

PRESSURE RATINGS

Generally, **Duolok** tube fittings are rated for pressures equal to the maximum allowable working pressures of the tubing recommended for use with the fittings. However, it is important to note that many specially designed fittings, bored-through fittings and fittings having AN, O-Seal and SAE/MS integral ends may have lower pressure ratings than that of the tubing. (See SSP's Selection Guide for Instrumentation Fittings and Tubing on pages 32-35 or contact your local Authorized Distributor for more information regarding tubing and fitting pressure ratings.)

TEMPERATURE FACTORS

Duolok tube fittings function reliably in applications ranging from cryogenic temperatures to high temperature bake out with the tube fitting material as the limiting factor. It is important to note that elevated temperatures may affect the maximum working pressure capability of the tubing system. (For more information regarding the effects of temperature on tubing pressure ratings, consult Table 2 on page 33.)

INTERCHANGEABILITY

Duolok tube fittings are designed, manufactured, quality controlled and distributed to be totally "interchangeable" with the Swagelok® brand of tube fittings. Component by component examination plainly shows the two brands as completely "component-intermixable". The precision manufacturing of both products to stringent tolerances under rigid quality control procedures ensures the safety, performance and reliability of service whenever Swagelok and **Duolok** component parts are mixed and used in accordance with published installation and service recommendations.

LIFETIME WARRANTY

Duolok tube fittings are covered by a published lifetime warranty as printed on the inside back cover of this catalog.

TUBE SELECTION

Careful selection and specification of tubing is essential to the performance of a tubing system. When choosing the appropriate tubing material, size and wall thickness, consideration must be given to the system's environment, pressures, temperatures and flows. (For more information on tube selection, please refer to Table 1 on page 33.)



Installation Instructions

INITIAL INSTALLATION

1. **Duolok** tube fittings come individually bagged and completely assembled for immediate use. There is no need for disassembly prior to use. Simply remove the tube fitting from its bag, insert the tube* until it bottoms in the **Duolok** tube fitting body and then hand tighten the **Duolok** nut. (See figure #1)

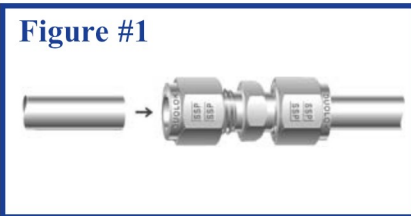

*Tubing ends should be cut as straight as possible with all O.D. and I.D. burrs removed. Use of a tubing cutter or guide blocks with a hacksaw is recommended.

[NOTE: For extreme system applications using high pressures or requiring an extra factor of safety, it may be desirable to use a “common make up starting point” to alleviate the inherent variations in tubing diameters. Installation should begin from a snug position, which is achieved by wrench tightening the **Duolok** nut until the inserted tubing will not move by hand (approximately 1/8 turn). From this new “snug” starting point, continue with the recommended installation instructions.]

2. While holding the fitting body stable with a back-up wrench, scribe the nut for a reference point and wrench tighten the nut 1-1/4 turns for sizes 6mm-25mm and 3/4 turn for sizes 3mm-5mm. (See Figures #2 and #3.)

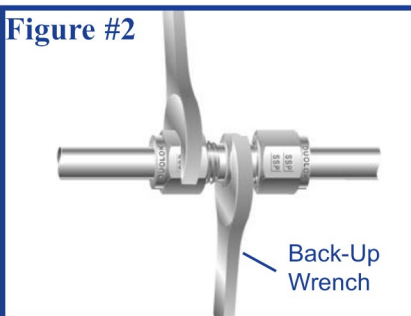
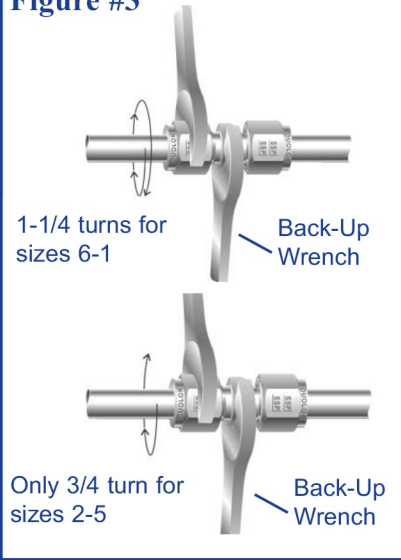

Figure #3



[NOTE: For all sizes, tighten plugs (P), machined ferrule end of port connector (PC) and the **Duolok** end of the Female AN adapter (ANF) only 1/4 of a turn. Tube fittings in sizes over 25mm require the use of the SSP Hydraulic Swaging Tool for installation. Contact your local SSP Distributor for more information]

REASSEMBLY INSTRUCTIONS

1. To reassemble a **Duolok** tube fitting connection, simply insert the tubing with the previously coined ferrules and **Duolok** nut into the fitting body until the front ferrule seats within the fitting body, and then tighten the nut by hand. (See Figure #4.)

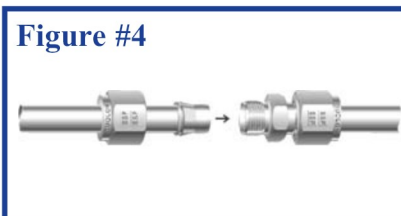

[NOTE: By following proper reassembly procedures, **Duolok** tube fitting connections may be disconnected and reconnected repeatedly.]

2. While holding the fitting body stable with a back up wrench, use a wrench to rotate the **Duolok** nut to the fitting’s original installation position (approximately 1/4 turn from the hand-tight, snug position) then continue to tighten the **Duolok** nut slightly. (See Figure #5.)

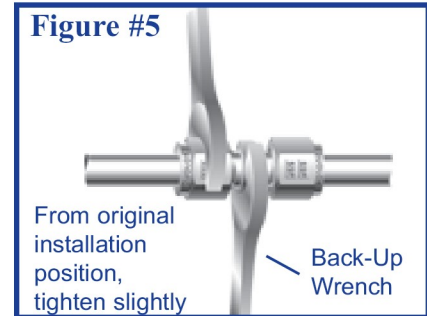

COMPONENT ASSEMBLY

Should individual component assembly of a **Duolok** tube fitting ever be required, careful attention must be given to the proper sequence and direction of the **Duolok** components. (See Figure #6.)

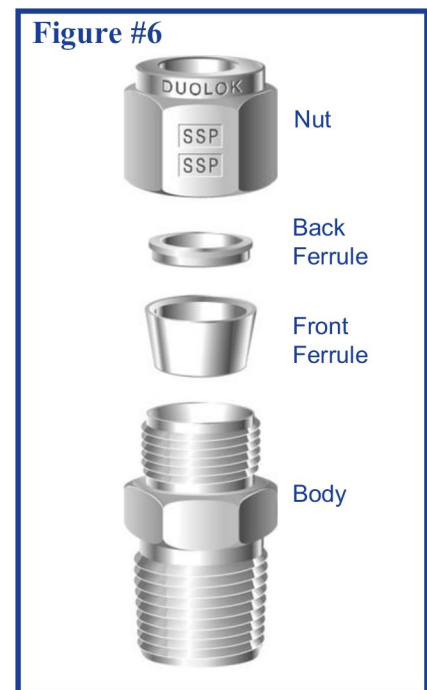

The **Duolok** pre-setting tool is used to pre-set the ferrules on the tubing for subsequent installation in a fitting body. The pre-setting tool can be especially helpful when an installation must be made in a tight space or hard-to-work area. The presetting tool allows the major portion of the installation work to occur in a more favorable work setting with only the completion of the installation in the hard-to-work area.

PRE-SETTING INSTRUCTIONS

1. Secure the pre-setting tool in a vise.
2. Remove the protective nut, and assemble the **Duolok** nut and ferrules loosely to the pre-setting tool. Insert the tubing through the nut and ferrules until it bottoms in the pre-setting tool, and then follow the standard **Duolok** tube fitting installation instructions from page 6. (See Figures #7A and #7B.)

Figure #7A

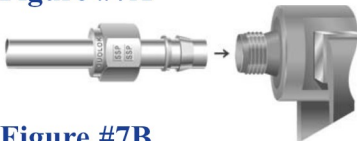
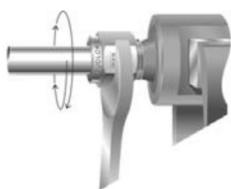
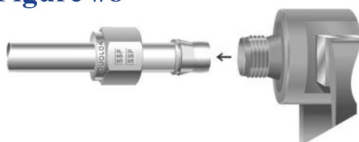

Figure #7B



3. Loosen the nut and remove the tubing with the pre-set **Duolok** ferrules and nut from the pre-setting tool. (See Figure #8.)

Figure #8



4. Installation of the tubing, with the pre-set **Duolok** ferrules and nut in the appropriate fitting body can now be made by following the standard reassembly instructions from page 6. (See Figures #9A and #9B.)

5. Return the protective nut to the presetting tool.

Figure #9A



Figure #9B

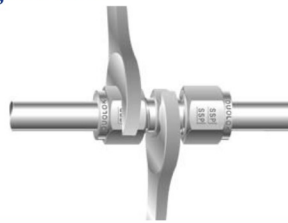

[NOTE: To extend the life of a pre-setting tool, lubricate the tool with a lubricant compatible with the system's tubing material, environment and media. Also, at times an oversized or very soft tubing may tend to stick in the presetting tool after make up. To remove the tubing, gently rock the tubing back and forth. Never turn the tube with pliers or another tool as such action may damage the sealing surfaces.]

GAGEABILITY

Each Duolok tube fitting component is manufactured with utmost precision to provide the optimum performance interaction of the components during assembly. By maintaining such stringent manufacturing tolerances, Duolok tube fittings are considered gageable for sufficient pull-up during initial installation. The Duolok "Gap Gages" are designed to identify for the installer or inspector, prior to pressurizing a system, that sufficient tightening of the tube fitting has occurred. Gageability provides additional reliability for proper installation and ultimate tube fitting safety and performance.

DUOLOK GAP GAGE INSTRUCTIONS

1. Follow proper installation instructions (as supplied with the fittings, or published in the **Duolok** catalog).
2. After completion of the installation instructions and prior to pressuring the system, choose the proper size Gap Gage and try to insert it between the fitting's nut and body hex. (See Figure #10).
3. If the Gap Gage will not enter between the fitting's nut and body hex, no additional tightening is required.
3. If the Gap Gage will enter between the fitting's nut and body hex, additional tightening is required.

[NOTE: Swagelok Gap Inspection Gages may also be utilized effectively with Duolok tube fittings.]









Figure #10



No Additional Tightening Required

Additional Tightening Required







Tube to Male Pipe

Male Connector 	Male Connector ISO Parallel 
MC 9	MCRS 10
Male Connector ISO Tapered 	Male Adapter 
MCRT 11	MA 26
Male Elbow 	Male Elbow ISO Tapered 
ME 12	MERT 13
Male Elbow ISO Parallel 	Male Branch Tee 
MERS 14	MBT 15
Male Run Tee 	
MRT 15	







Tube to Welded System

Male Pipe Weld Connector 
MPWC 24





Tube to Female Pipe

Female Connector 	Female Connector ISO Tapered 	Female Connector ISO Parallel 
FC 17	FCRT 18	FCRG 19
Female Adapter 	Female Run Tee 	Female Elbow 
FA 29	FRT 20	FE 20
	Female Branch Tee 	
	FBT 21	



Tube to Tube Union

Union 	Bulkhead Union 	Reducing Union 
U 20	BU 21	RU 21
Union Elbow 	Union Tee 	Union Cross 
UE 22	UT 23	UCS 22







Tube Stub Connectors/Adapters

Reducer/Adapter 	Male Adapter 	Female Adapter 
R 25	MA 26	FA 27
Port Connector 	Reducing Port Connector 	
PC 28	RPC 28	

Cap & Plug

Cap 	Plug 
CP 29	P 29

Components

Nut 	Back Ferrule 	Front Ferrule 
N 30	BF 30	FF 30
Ferrule Set 	Tube Insert 	Bonded Washer 
FS 31	TI 31	DW 31

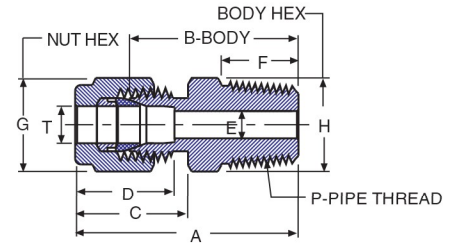

Male Connector -NPT (MC)

Duolok Part#	T TUBE O.D.	P-NPT MALE PIPE SIZE	A	B	C	D	E Minimum Opening	F	G	H	Code Pressure (psig)
DM3MC2	3	1/8	30.5	23.9	15.3	12.9	2.4	9.7	12	12	8,300
DM3MC4	3	1/4	35.6	29.0	15.3	12.9	2.4	14.2	12	14	10,100
DM4MC2	4	1/8	31.2	24.6	16.1	13.7	2.4	9.7	12	12	8,300
DM4MC4	4	1/4	36.3	29.7	16.1	13.7	2.4	14.2	12	14	10,100
DM6MC2	6	1/8	32.8	25.4	17.7	15.3	4.8	9.7	14	14	10,100
DM6MC4	6	1/4	37.9	30.5	17.7	15.3	4.8	14.2	14	14	8,300
DM6MC6	6	3/8	38.4	31.0	17.7	15.3	4.8	14.2	14	18	7,850
DM6MC8	6	1/2	44.7	37.3	17.7	15.3	4.8	19.0	14	22	7,750
DM8MC2	8	1/8	34.2	26.7	18.6	16.2	4.8	9.7	16	15	7,750
DM8MC4	8	1/4	38.7	31.2	18.6	16.2	6.4	14.2	16	15	7,750
DM8MC6	8	3/8	39.3	31.8	18.6	16.2	6.4	14.2	16	18	7,750
DM8MC8	8	1/2	45.6	38.1	18.6	16.2	6.4	19.0	16	22	7,750
DM10MC2	10	1/8	36.3	28.7	19.5	17.2	4.8	9.7	19	18	9,150
DM10MC4	10	1/4	40.9	33.3	19.5	17.2	7.1	14.2	19	18	8,300
DM10MC6	10	3/8	40.9	33.3	19.5	17.2	7.9	14.2	19	18	7,850
DM10MC8	10	1/2	46.5	38.9	19.5	17.2	7.9	19.0	19	22	7,750
DM10MC12	10	3/4	48.0	40.4	19.5	17.2	7.9	19.0	19	27	7,350
DM12MC2	12	1/8	38.8	28.7	22.0	22.8	4.8	9.7	22	22	10,100
DM12MC4	12	1/4	43.4	33.3	22.0	22.8	7.1	14.2	22	22	8,300
DM12MC6	12	3/8	43.4	33.3	22.0	22.8	9.5	14.2	22	22	7,850
DM12MC8	12	1/2	49.0	38.9	22.0	22.8	9.5	19.0	22	22	7,750
DM12MC12	12	3/4	50.5	40.4	22.0	22.8	9.5	19.0	22	27	7,750
DM14MC4	14	1/4	44.1	34.0	22.0	24.4	7.1	14.2	25	24	8,300
DM14MC6	14	3/8	44.1	34.0	22.0	24.4	9.5	14.2	25	24	7,850
DM14MC8	14	1/2	49.0	38.9	22.0	24.4	11.1	19.0	25	24	7,750
DM15MC8	15	1/2	49.0	38.9	22.0	24.4	11.9	19.0	25	24	7,750
DM16MC6	16	3/8	44.1	34.0	22.0	24.4	9.5	14.2	25	24	5,900
DM16MC8	16	1/2	49.0	38.9	22.0	24.4	11.9	19.0	25	24	5,900
DM16MC12	16	3/4	50.5	40.4	22.0	24.4	12.7	19.0	25	27	5,900
DM18MC8	18	1/2	50.5	40.4	22.0	24.4	11.9	19.0	30	27	6,800
DM18MC12	18	3/4	50.5	40.4	22.0	24.4	15.1	19.0	30	27	6,800
DM20MC8	20	1/2	52.3	42.2	22.0	26.0	11.9	19.0	32	30	7,600
DM20MC12	20	3/4	52.3	42.2	22.0	26.0	15.9	19.0	32	30	7,350
DM22MC12	22	3/4	52.3	42.2	22.0	26.0	15.9	19.0	32	30	4,550
DM22MC16	22	1	57.1	47.0	22.0	26.0	18.3	23.9	32	35	4,550
DM25MC8	25	1/2	57.5	45.2	26.5	31.3	11.9	19.0	38	35	5,650
DM25MC12	25	3/4	57.5	45.2	26.5	31.3	15.9	19.0	38	35	5,650
DM25MC16	25	1	62.3	50.0	26.5	31.3	21.8	23.9	38	35	5,500

Finger-tight assembly dimensions (shown in millimeters) are for reference only and subject to change.
 Code Pressures per ASME B31.3 Refer to *Selection Guide for Instrumentation Tubing for Working Pressures*.
 Visit www.sspfittings.com for controlled version of data.

Fractional Tube to ISO Thread Fittings

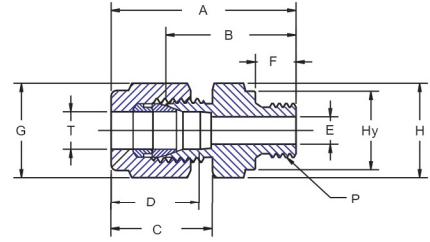

Male Connector - ISO Parallel (MCRS)

Duolok Part #	T TUBE O.D.	P ISO MALE PIPE	A	F	C	D	E Minimum Opening	H Hex Flat	Hy	G	B Body	Code Pressure (psig)
DM3MCRS2	3	1/8	33.3	7.1	15.3	12.9	2.4	14	13.8	12	23.4	18,650
DM3MCRS4	3	1/4	38.1	11.2	15.3	12.9	2.4	19	18.0	12	28.7	12,100
DM4MCRS2	4	1/8	34.0	7.1	16.1	13.7	2.4	14	13.8	12	24.1	18,650
DM6MCRS2	6	1/8	35.6	7.1	17.7	15.3	4.0	14	13.8	14	24.9	12,800
DM6MCRS4	6	1/4	40.4	11.2	17.7	15.3	4.8	19	18.0	14	30.2	12,100
DM6MCRS6	6	3/8	41.1	11.2	17.7	15.3	4.8	22	21.8	14	31.5	8,250
DM6MCRS8	6	1/2	43.2	14.2	17.7	15.3	4.8	27	26.0	14	37.3	9,100
DM8MCRS2	8	1/8	36.6	7.1	18.6	16.2	4.0	15	13.8	16	25.7	7,750
DM8MCRS4	8	1/4	41.4	11.2	18.6	16.2	6.4	19	18.0	16	31.0	7,750
DM8MCRS6	8	3/8	42.2	11.2	18.6	16.2	6.4	22	21.8	16	32.3	7,750
DM8MCRS8	8	1/2	44.2	14.2	18.6	16.2	6.4	27	26.0	16	38.1	7,750
DM10MCRS4	10	1/4	42.2	11.2	19.5	17.2	5.9	19	18.0	19	31.8	9,150
DM10MCRS6	10	3/8	42.9	11.2	19.5	17.2	7.9	22	21.8	19	33.0	8,250
DM10MCRS8	10	1/2	45.0	14.2	19.5	17.2	7.9	27	26.0	19	38.9	9,100
DM12MCRS4	12	1/4	44.5	11.2	22.0	22.8	5.9	22	18.0	22	32.5	10,200
DM12MCRS6	12	3/8	45.5	11.2	22.0	22.8	7.9	22	21.8	22	33.0	8,250
DM12MCRS8	12	1/2	47.5	14.2	22.0	22.8	9.5	27	26.0	22	38.9	9,100
DM12MCRS12	12	3/4	52.1	15.7	22.0	22.8	9.5	35	32.0	22	42.7	7,800
DM16MCRS6	16	3/8	45.5	11.2	22.0	24.4	7.9	24	21.8	25	33.8	5,900
DM16MCRS8	16	1/2	47.5	14.2	22.0	24.4	11.9	27	26.0	25	38.9	5,900
DM18MCRS8	18	1/2	48.8	14.2	22.0	24.4	11.9	27	26.0	30	38.9	6,800
DM18MCRS12	18	3/4	52.1	15.7	22.0	24.4	15.1	35	32.0	30	42.7	6,800
DM20MCRS8	20	1/2	50.5	14.2	22.0	26.0	11.9	30	26.0	32	40.4	7,600
DM20MCRS12	20	3/4	52.6	15.7	22.0	26.0	15.9	35	32.0	32	42.7	4,600
DM22MCRS12	22	3/4	52.6	15.7	22.0	26.0	15.9	35	32.0	32	42.7	4,550
DM22MCRS16	22	1	54.9	18.3	22.0	26.0	18.3	41	39.0	32	45.2	4,550
DM25MCRS12	25	3/4	57.7	15.7	26.5	31.3	15.9	35	32.0	38	45.2	5,650
DM25MCRS16	25	1	59.7	18.3	26.5	31.3	19.8	41	39.0	38	47.8	5,650

NOTE: RS threaded fittings conform to ISO standards 228/1. The standard gasket for RS fittings is a 300 series stainless steel outer ring with a Buna inner ring bonded to it.

Bonded Washer (DW)

Duolok Part #	ISO PIPE SIZE	E	A	L
2DW-BSPP	1/8	10.4	16.0	2.0
4DW-BSPP	1/4	13.7	20.6	2.0
6DW-BSPP	3/8	17.3	23.9	2.0
8DW-BSPP	1/2	21.6	28.7	2.5
12DW-BSPP	3/4	26.9	35.1	2.5
16DW-BSPP	1	33.8	42.9	2.5

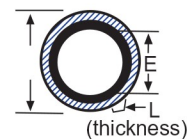

Finger-tight assembly dimensions (shown in millimeters) are for reference only and subject to change.
Code Pressures per ASME B31.3 Refer to Selection Guide for Instrumentation Tubing for Working Pressures.
 Visit www.ssp fittings.com for controlled version of data.

Fractional Tube to ISO Thread Fittings

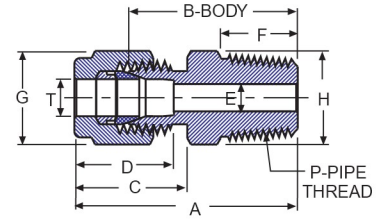

Male Connector - ISO Tapered (MCRT)

Duolok Part #	T TUBE O.D.	P ISO MALE PIPE	A	F	C	D	E Minimum Opening	H Hex Flat	G Hex Flat	B Body	Code Pressure (psig)
DM4MCRT2	4	1/8	31.2	9.7	16.1	13.7	2.4	12	12	24.6	11,000
DM4MCRT4	4	1/4	36.3	14.2	16.1	13.7	2.4	14	14	29.7	10,350
DM6MCRT2	6	1/8	32.8	9.7	17.7	15.3	4.8	14	14	25.4	11,000
DM6MCRT4	6	1/4	37.9	14.2	17.7	15.3	4.8	14	14	30.5	10,350
DM6MCRT6	6	3/8	38.4	14.2	17.7	15.3	4.8	18	18	31.0	7,100
DM6MCRT8	6	1/2	44.7	19.0	17.7	15.3	4.8	22	22	37.3	6,300
DM8MCRT2	8	1/8	34.2	9.7	18.6	16.2	4.8	15	15	26.7	7,750
DM8MCRT4	8	1/4	38.7	14.2	18.6	16.2	6.4	15	15	31.2	7,750
DM8MCRT6	8	3/8	39.2	14.2	18.6	16.2	6.4	18	18	31.8	7,100
DM8MCRT8	8	1/2	54.6	19.0	18.6	16.2	6.4	22	22	38.1	6,300
DM10MCRT2	10	1/8	36.3	9.7	19.5	17.2	4.8	18	18	28.7	9,150
DM10MCRT4	10	1/4	40.9	14.2	19.5	17.2	7.1	18	18	33.3	9,150
DM10MCRT6	10	3/8	40.9	14.2	19.5	17.2	7.9	18	18	33.3	7,100
DM10MCRT8	10	1/2	46.5	19.0	19.5	17.2	7.9	22	22	38.9	6,300
DM12MCRT4	12	1/4	43.4	14.2	22.0	22.8	7.1	22	22	33.3	10,200
DM12MCRT6	12	3/8	43.4	14.2	22.0	22.8	9.5	22	22	33.3	7,100
DM12MCRT8	12	1/2	49.0	19.0	22.0	22.8	9.5	22	22	38.9	6,300
DM12MCRT12	12	3/4	50.5	19.0	22.0	22.8	9.5	27	27	40.4	6,000
DM15MCRT8	15	1/2	49.0	19.0	22.0	24.4	11.9	24	24	38.9	6,300
DM16MCRT4	16	1/4	44.1	14.2	22.0	24.4	7.1	24	24	34.0	5,900
DM16MCRT6	16	3/8	44.1	14.2	22.0	24.4	9.5	24	24	34.0	5,900
DM16MCRT8	16	1/2	49.0	19.0	22.0	24.4	11.9	24	24	38.9	5,900
DM16MCRT12	16	3/4	50.5	19.0	22.0	24.4	12.7	27	27	40.4	5,900
DM18MCRT8	18	1/2	50.5	19.0	22.0	24.4	11.9	27	27	40.4	6,300
DM18MCRT12	18	3/4	50.5	19.0	22.0	24.4	15.1	27	27	40.4	6,000
DM20MCRT8	20	1/2	52.3	19.0	22.0	26.0	11.9	30	30	42.2	6,300
DM20MCRT12	20	3/4	52.3	19.0	22.0	26.0	15.9	30	30	42.2	6,000
DM22MCRT8	22	1/2	52.3	19.0	22.0	26.0	15.9	30	30	42.2	4,550
DM22MCRT12	22	1	57.1	23.9	22.0	26.0	18.3	35	35	47.0	4,550
DM25MCRT8	25	1/2	57.5	19.0	26.5	31.3	15.9	35	35	45.2	5,650
DM25MCRT12	25	1	62.3	23.9	26.5	31.3	21.8	35	35	45.2	5,650

NOTE: RT threaded fittings conform to ISO standard 7/1.

Tube to Male Pipe

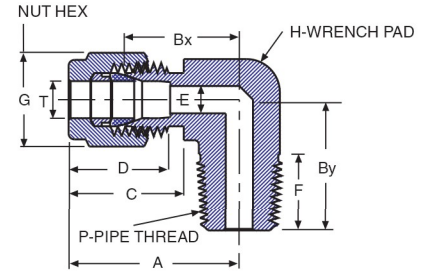

Male Elbow - NPT (ME)

Duolok Part #	T TUBE O.D.	P NPT MALE PIPE	A	Bx	By	C	D	E Minimum Opening	F Min.	H (inch)	Code Pressure (psig)
DM3ME2	3	1/8	23.6	17.0	17.8	15.3	12.9	2.4	9.7	7/16	10,100
DM3ME4	3	1/4	24.6	18.0	23.4	15.3	12.9	2.4	14.2	1/2	8,300
DM4ME2	4	1/8	25.4	18.8	18.8	16.1	13.7	2.4	9.7	1/2	10,100
DM4ME4	4	1/4	25.4	18.8	23.4	16.1	13.7	2.4	14.2	1/2	8,300
DM6ME2	6	1/8	27.0	19.6	18.8	17.7	15.3	4.8	9.7	1/2	10,100
DM6ME4	6	1/4	27.0	19.6	23.4	17.7	15.3	4.8	14.2	1/2	8,300
DM6ME6	6	3/8	29.8	22.4	26.2	17.7	15.3	4.8	14.2	11/16	7,850
DM6ME8	6	1/2	31.8	24.4	33.0	17.7	15.3	4.8	19.0	13/16	7,750
DM8ME2	8	1/8	28.8	21.3	19.8	18.6	16.2	4.8	9.7	9/16	7,750
DM8ME4	8	1/4	28.8	21.3	24.4	18.6	16.2	6.4	14.2	9/16	7,750
DM8ME6	8	3/8	30.6	23.1	26.2	18.6	16.2	6.4	14.2	11/16	7,750
DM8ME8	8	1/2	32.6	25.1	33.0	18.6	16.2	6.4	19.0	13/16	7,750
DM10ME2	10	1/8	31.5	23.9	21.6	19.5	17.2	4.8	9.7	11/16	9,150
DM10ME4	10	1/4	31.5	23.9	26.2	19.5	17.2	7.1	14.2	11/16	8,300
DM10ME6	10	3/8	31.5	23.9	26.2	19.5	17.2	7.9	14.2	11/16	7,850
DM10ME8	10	1/2	33.5	25.9	33.0	19.5	17.2	7.9	19.0	13/16	7,750
DM12ME4	12	1/4	36.0	25.9	28.2	22.0	22.8	7.1	14.2	13/16	8,300
DM12ME6	12	3/8	36.0	25.9	28.2	22.0	22.8	9.5	14.2	13/16	7,850
DM12ME8	12	1/2	36.0	25.9	33.0	22.0	22.8	9.5	19.0	13/16	7,750
DM12ME12	12	3/4	39.8	29.7	36.8	22.0	22.8	9.5	19.0	1-1/16	7,350
DM15ME8	15	1/2	38.0	27.9	35.1	22.0	24.4	11.9	19.0	15/16	7,750
DM16ME6	16	3/8	38.0	27.9	30.2	22.0	24.4	9.5	14.2	15/16	5,900
DM16ME8	16	1/2	38.0	27.9	35.1	22.0	24.4	11.9	19.0	15/16	5,900
DM16ME12	16	3/4	39.8	29.7	36.8	22.0	24.4	12.7	19.0	1-1/16	5,900
DM18ME8	18	1/2	39.8	29.7	36.8	22.0	24.4	11.9	19.0	1-1/16	6,800
DM18ME12	18	3/4	39.8	29.7	36.8	22.0	24.4	15.1	19.0	1-1/16	6,800
DM20ME8	20	1/2	44.6	34.5	41.7	22.0	26.0	11.9	19.0	1-3/8	7,600
DM20ME12	20	3/4	44.6	34.5	41.7	22.0	26.0	15.9	19.0	1-3/8	7,350
DM22ME12	22	3/4	44.6	34.5	41.7	22.0	26.0	15.9	19.0	1-3/8	4,550
DM22ME16	22	1	44.6	34.5	46.5	22.0	26.0	18.3	23.9	1-3/8	4,550
DM25ME12	25	3/4	49.1	36.8	41.7	26.5	31.3	15.9	19.0	1-3/8	5,650
DM25ME16	25	1	49.1	36.8	46.5	26.5	31.3	21.8	23.9	1-3/8	5,500

Finger-tight assembly dimensions (shown in millimeters) are for reference only and subject to change.
 Code Pressures per ASME B31.3 Refer to *Selection Guide for Instrumentation Tubing for Working Pressures*.
 Visit www.sspittings.com for controlled version of data.

Fractional Tube to ISO Thread Fittings

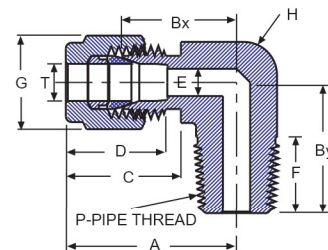

Male Elbow - ISO Tapered (MERT)

Duolok Part #	T Tube O.D.	P ISO MALE PIPE	A	F	C	D	E Minimum Opening	H Wrench Pad (inch)	G Hex Flat	Bx	By	Working Pressure (psig)
DM3MERT2	3	1/8	23.6	9.7	15.3	12.9	2.4	7/16	12	17.0	17.8	11,000
DM3MERT4	3	1/4	24.6	14.2	15.3	12.9	2.4	1/2	12	18.0	23.4	10,350
DM4MERT2	4	1/8	25.4	9.7	16.1	13.7	2.4	1/2	12	18.8	18.8	11,000
DM4MERT4	4	1/4	25.4	14.2	16.1	13.7	2.4	1/2	12	18.8	23.4	10,350
DM6MERT2	6	1/8	27.0	9.7	17.7	15.3	4.8	1/2	14	19.6	18.8	11,000
DM6MERT4	6	1/4	27.0	14.2	17.7	15.3	4.8	1/2	14	19.6	23.4	10,350
DM6MERT6	6	3/8	29.8	14.2	17.7	15.3	4.8	11/16	14	22.4	26.2	7,100
DM6MERT8	6	1/2	31.8	19.0	17.7	15.3	4.8	13/16	14	24.4	33.0	6,300
DM8MERT2	8	1/8	28.8	9.7	18.6	16.2	4.8	9/16	16	21.3	19.8	7,750
DM8MERT4	8	1/4	28.8	14.2	18.6	16.2	6.4	9/16	16	21.3	24.4	7,750
DM8MERT6	8	3/8	30.6	14.2	18.6	16.2	6.4	11/16	16	23.1	26.2	7,100
DM8MERT8	8	1/2	32.6	19.0	18.6	16.2	6.4	13/16	16	25.1	33.0	6,300
DM10MERT4	10	1/4	31.5	14.2	19.5	17.2	7.1	11/16	19	23.9	26.2	9,150
DM10MERT6	10	3/8	31.5	14.2	19.5	17.2	7.9	11/16	19	23.9	26.2	9,150
DM10MERT8	10	1/2	33.5	19.0	19.5	17.2	7.9	13/16	19	25.9	33.0	7,100
DM12MERT2	12	1/8	36.0	9.7	22.0	22.8	4.8	13/16	22	25.9	23.6	6,300
DM12MERT4	12	1/4	36.0	14.2	22.0	22.8	7.1	13/16	22	25.9	28.2	10,200
DM12MERT6	12	3/8	36.0	14.2	22.0	22.8	9.5	13/16	22	25.9	28.2	7,100
DM12MERT8	12	1/2	36.0	19.0	22.0	22.8	9.5	13/16	22	25.9	33.0	6,300
DM12MERT12	12	3/4	39.8	19.0	22.0	22.8	9.5	1-1/16	22	29.7	36.8	6,000
DM16MERT6	16	3/8	38.0	14.2	22.0	24.4	9.5	15/16	25	27.9	30.2	5,900
DM16MERT8	16	1/2	38.0	19.0	22.0	24.2	11.9	15/16	25	27.9	35.1	5,900
DM18MERT8	18	1/2	39.8	19.0	22.0	24.4	11.9	1-1/16	30	29.7	36.8	6,300
DM18MERT12	18	3/4	39.8	19.0	22.0	24.4	15.1	1-1/16	30	29.7	36.8	6,000
DM20MERT8	20	1/2	44.6	19.0	22.0	26.0	11.9	1-3/8	32	34.5	41.7	6,300
DM20MERT12	20	3/4	44.6	19.0	22.0	26.0	15.9	1-3/8	32	34.5	41.7	6,000
DM22MERT12	22	3/4	44.6	19.0	22.0	26.0	15.9	1-3/8	32	34.5	41.7	4,550
DM22MERT16	22	1	44.6	23.9	22.0	26.0	18.3	1-3/8	32	34.5	46.5	5,500
DM25MERT12	25	3/4	49.1	19.0	26.5	31.3	15.9	1-3/8	38	36.8	41.7	5,650
DM25MERT16	25	1	49.1	23.9	26.5	31.3	21.8	1-3/8	38	36.8	46.5	5,100

NOTE: RT threaded fittings conform to ISO standard 7/1.

Tube to Male Pipe

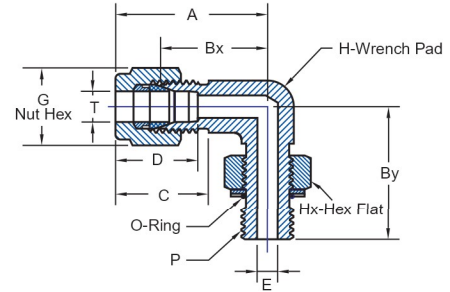
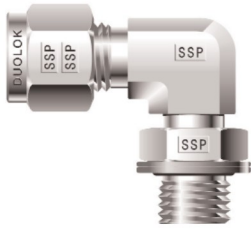

Male Elbow - ISO Parallel (MERS)

Duolok Part #	T TUBE O.D.	P ISO MALE PIPE	A	Bx	By	C	D	E	F	G	H (inch)	Hx (inch)	Code Pressure (psig)
DM6MERS2	6	1/8	27.0	19.6	26.4	17.7	15.3	4	8.1	14	9/16	9/16	9,300
DM6MERS4	6	1/4	29.0	21.6	32.3	17.7	15.3	4.8	9.1	14	3/4	3/4	9,850
DM8MERS2	8	1/8	28.8	21.3	27.4	18.6	16.2	4	8.1	16	9/16	9/16	7,750
DM8MERS4	8	1/4	29.9	22.4	32.2	18.6	16.2	5.9	9.1	16	5/8	3/4	7,750
DM10MERS4	10	1/4	33.5	25.9	35.0	19.5	17.2	5.9	9.1	19	13/16	3/4	9,150
DM10MERS6	10	3/8	33.5	25.9	37.1	19.5	17.2	7.9	9.4	19	15/16	7/8	6,200
DM12MERS4	12	1/4	36.0	25.9	35.0	22.0	22.8	5.9	9.1	22	13/16	3/4	9,850
DM12MERS6	12	3/8	36.0	25.9	37.1	22.0	22.8	7.9	9.4	22	15/16	7/8	6,200
DM12MERS8	12	1/2	38.0	27.9	43.4	22.0	22.8	9.5	13.0	22	1-1/16	1-1/16	7,000
DM12MERS12	12	3/4	39.8	29.7	48.8	22.0	22.8	9.5	13.0	22	1-1/16	1-3/8	7,650

NOTE: RS threaded fittings conform to ISO standards 228/1. The standard gasket for RS fittings is a 300 series stainless steel outer ring with a Buna inner ring bonded to it.

Bonded Washer (DW)

Duolok Part #	ISO PIPE SIZE	E	A	L
2DW-BSPP	1/8	10.4	16.0	2.0
4DW-BSPP	1/4	13.7	20.6	2.0
6DW-BSPP	3/8	17.3	23.9	2.0
8DW-BSPP	1/2	21.6	28.7	2.5
12DW-BSPP	3/4	26.9	35.1	2.5
16DW-BSPP	1	33.8	42.9	2.5

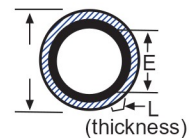

Finger-tight assembly dimensions (shown in millimeters) are for reference only and subject to change.
 Code Pressures per ASME B31.3 Refer to *Selection Guide for Instrumentation Tubing for Working Pressures*.
 Visit www.sspittings.com for controlled version of data.

Tube to Female Pipe

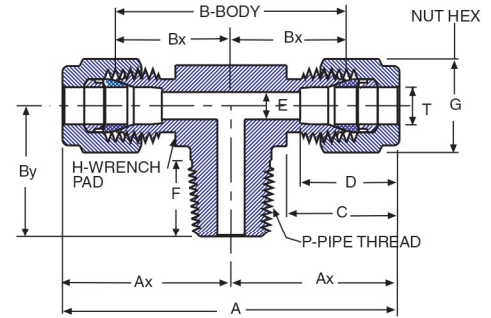

Male Branch Tee - NPT (MBT)

Duolok Part #	T TUBE O.D.	P NPT MALE PIPE	A	Ax	B	Bx	By	C	D	E Minimum Opening	F Min	G	H (inch)	Code Pressure (psig)
DM6MBT2	6	1/8	53.9	27.0	39.1	19.6	18.8	17.7	15.3	4.8	9.7	14	1/2	10,100
DM6MBT4	6	1/4	53.9	27.0	39.1	19.6	23.4	17.7	15.3	4.8	14.2	14	9/16	8,300
DM8MBT2	8	1/8	59.7	29.9	44.7	22.4	20.8	18.6	16.2	4.8	9.7	16	5/8	7,750
DM8MBT4	8	1/4	59.7	29.9	44.7	22.4	25.4	18.6	16.2	6.4	14.2	16	5/8	7,750
DM10MBT4	10	1/4	67.0	33.5	51.8	25.9	28.2	19.5	17.2	7.1	14.2	19	13/16	8,300
DM12MBT4	12	1/4	72.0	36.0	51.8	25.9	28.2	22.0	22.8	7.1	14.2	22	13/16	8,300
DM12MBT6	12	3/8	72.0	36.0	51.8	25.9	28.2	22.0	22.8	9.5	14.2	22	13/16	7,850
DM12MBT8	12	1/2	72.0	36.0	51.8	25.9	33.0	22.0	22.8	9.5	19.0	22	13/16	7,750
DM16MBT8	16	1/2	77.6	38.8	57.4	28.7	35.8	22.0	24.4	11.9	19.0	25	1	5,900

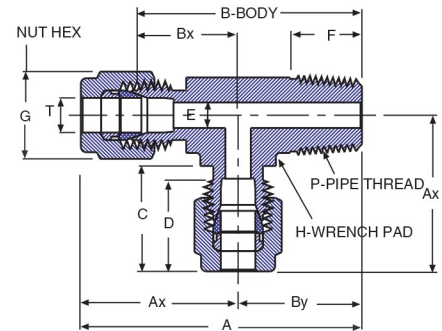
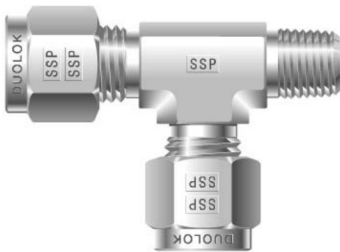

Male Run Tee - NPT (MRT)

Duolok Part #	T TUBE O.D.	P NPT MALE PIPE	A	AX	B	Bx	By	C	D	E Minimum Opening	F Min.	G	H (inch)	Code Pressure (psig)
DM6MRT2	6	1/8	45.8	27.0	38.4	19.6	18.0	17.7	15.3	4.8	9.7	14	1/2	10,100
DM6MRT4	6	1/4	50.3	27.0	42.9	19.6	23.4	17.7	15.3	4.8	14.2	14	9/16	8,300
DM8MRT4	8	1/4	55.3	29.9	47.8	22.4	25.4	18.6	16.2	6.4	14.2	16	5/8	7,750
DM12MRT4	12	1/4	64.2	36.0	54.1	25.9	28.2	22.0	22.8	7.1	14.2	22	13/16	8,300
DM12MRT8	12	1/2	69.0	36.0	58.9	25.9	33.0	22.0	22.8	9.5	19.0	22	13/16	7,750
DM16MRT8	16	1/2	73.1	38.0	63.0	27.9	35.0	22.0	24.4	11.9	19.0	25	1	5,900

Finger-tight assembly dimensions (shown in millimeters) are for reference only and subject to change.
 Code Pressures per ASME B31.3 Refer to *Selection Guide for Instrumentation Tubing for Working Pressures*.
 Visit www.sspfittings.com for controlled version of data.

Tube to Female Pipe

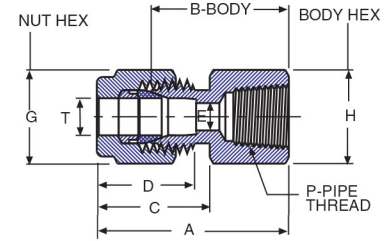

Female Connector - NPT (FC)

Duolok Part #	T TUBE O.D.	P NPT FEMALE PIPE	A	B	C	D	E Minimum Opening	G	H	Code Pressure (psig)
DM3FC2	3	1/8	28.7	22.1	15.3	12.9	2.4	12	14	8,950
DM3FC4	3	1/4	33.5	26.9	15.3	12.9	2.4	12	19	9,050
DM4FC2	4	1/8	29.7	23.1	16.1	13.7	2.4	12	14	8,950
DM6FC2	6	1/8	31.3	23.9	17.7	15.3	4.8	14	14	12,800
DM6FC4	6	1/4	35.8	28.4	17.7	15.3	4.8	14	19	9,050
DM6FC6	6	3/8	37.6	30.2	17.7	15.3	4.8	14	22	6,650
DM6FC8	6	1/2	42.5	35.1	17.7	15.3	4.8	14	27	5,800
DM8FC2	8	1/8	32.1	24.6	18.6	16.2	6.4	16	15	8,000
DM8FC4	8	1/4	37.0	29.5	18.6	16.2	6.4	16	19	7,750
DM8FC6	8	3/8	38.5	31.0	18.6	16.2	6.4	16	22	6,650
DM8FC8	8	1/2	43.3	35.8	18.6	16.2	6.4	16	27	5,800
DM10FC4	10	1/4	37.8	30.2	19.5	17.2	7.9	19	19	9,100
DM10FC6	10	3/8	39.4	31.8	19.5	17.2	7.9	19	22	9,100
DM10FC8	10	1/2	44.2	36.6	19.5	17.2	7.9	19	27	5,800
DM12FC4	12	1/4	40.3	30.2	22.0	22.8	9.5	22	22	8,800
DM12FC6	12	3/8	41.9	31.8	22.0	22.8	9.5	22	22	9,100
DM12FC8	12	1/2	46.7	36.6	22.0	22.8	9.5	22	27	5,800
DM15FC8	15	1/2	46.7	36.6	22.0	24.4	11.9	25	27	5,800
DM16FC8	16	1/2	46.9	36.8	22.0	24.4	12.7	25	27	5,800
DM20FC8	20	1/2	47.9	37.8	22.0	26.0	15.9	32	30	5,800
DM20FC12	20	3/4	49.7	39.6	22.0	26.0	15.9	32	35	5,450
DM22FC12	22	3/4	49.7	39.6	22.0	26.0	18.3	32	35	4,550
DM22FC16	22	1	57.9	47.8	22.0	26.0	18.3	32	41	4,550
DM25FC12	25	3/4	53.4	41.1	26.5	31.3	21.8	38	35	5,450
DM25FC16	25	1	62.3	50.0	26.5	31.3	21.8	38	41	5,150

Finger-tight assembly dimensions (shown in millimeters) are for reference only and subject to change.
 Code Pressures per ASME B31.3 Refer to *Selection Guide for Instrumentation Tubing for Working Pressures*.
 Visit www.ssp fittings.com for controlled version of data.

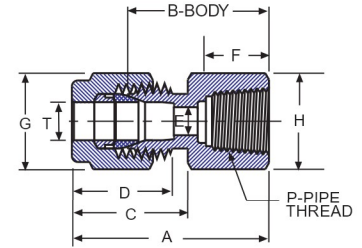

Female Connector - ISO Tapered (FCRT)

Duolok Part #	T TUBE O.D.	P ISO FEMALE PIPE	A	B	C	D	E Minimum Opening	F	G	H	Code Pressure (psig)
DM3FCRT2	3	1/8	28.7	22.1	15.3	12.9	2.4	10.4	12	14	8,950
DM6FCRT2	6	1/8	31.3	23.9	17.7	15.3	4.8	10.4	14	14	12,800
DM6FCRT4	6	1/4	35.8	28.4	17.7	15.3	4.8	15.0	14	19	9,050
DM6FCRT6	6	3/8	37.6	30.2	17.7	15.3	4.8	15.0	14	22	6,650
DM6FCRT8	6	1/2	42.5	35.1	17.7	15.3	4.8	19.8	14	27	5,800
DM8FCRT2	8	1/8	32.1	24.6	18.6	16.2	6.4	10.4	16	15	7,750
DM8FCRT4	8	1/4	37.0	29.5	18.6	16.2	6.4	15.0	16	19	7,750
DM8FCRT6	8	3/8	38.5	31.0	18.6	16.2	6.4	15.0	16	22	5,800
DM8FCRT8	8	1/2	43.3	35.8	18.6	16.2	6.4	19.8	16	27	5,800
DM10FCRT2	10	1/8	33.0	25.4	19.5	17.2	7.9	10.4	19	18	9,150
DM10FCRT4	10	1/4	37.8	30.2	19.5	17.2	7.9	15.0	19	19	9,100
DM10FCRT6	10	3/8	39.4	31.8	19.5	17.2	7.9	19.5	19	22	9,100
DM10FCRT8	10	1/2	44.2	36.6	19.5	17.2	7.9	19.8	19	27	5,800
DM12FCRT2	12	1/8	35.5	25.4	22.0	22.8	8.3	10.4	22	22	10,200
DM12FCRT4	12	1/4	40.3	30.2	22.0	22.8	9.5	15.0	22	22	8,800
DM12FCRT6	12	3/8	41.9	31.8	22.0	22.8	9.5	15.0	22	22	9,100
DM12FCRT8	12	1/2	46.7	36.6	22.0	22.8	9.5	19.8	22	27	5,800
DM12FCRT12	12	3/4	49.0	38.9	22.0	22.8	9.5	20.6	22	35	5,450
DM15FCRT6	15	3/8	41.9	31.8	22.0	24.4	11.9	15.0	25	24	8,050
DM15FCRT8	15	1/2	46.7	36.6	22.0	24.4	11.9	19.8	25	27	5,800
DM20FCRT8	20	1/2	47.9	37.8	22.0	26.0	15.9	19.8	32	30	5,450
DM20FCRT12	20	3/4	49.7	39.6	22.0	26.0	15.9	20.6	32	35	5,800
DM22FCRT12	22	3/4	49.7	39.6	22.0	26.0	18.3	20.6	32	35	4,550
DM22FCRT16	22	1	57.9	47.8	22.0	26.0	18.3	25.4	32	41	4,550
DM25FCRT12	25	3/4	53.4	41.1	26.5	31.3	21.8	20.6	38	35	5,450
DM25FCRT16	25	1	62.3	50.0	26.5	31.3	21.8	25.4	38	41	5,150

NOTE: RT threaded fittings conform to ISO standard 7/1.

Tube to Female Pipe

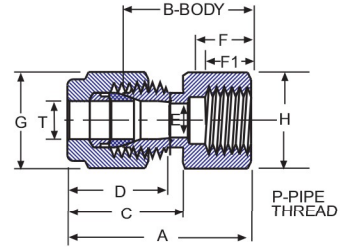

Female Connector - ISO Parallel (FCRG)

Duolok Part #	T TUBE O.D.	P ISO FEMALE PIPE	A	B	C	D	E	F	F1	G	H	Code Pressure (psig)
DM3FCRG4	3	1/4	35.3	28.7	15.3	12.9	2.4	13.0	9.5	12	19	9,300
DM6FCRG4	6	1/4	37.6	30.2	17.7	15.3	4.8	13.0	9.5	14	19	9,300
DM6FCRG6	6	3/8	37.6	30.2	17.7	15.3	4.8	14.0	10.0	14	24	7,750
DM6FCRG8	6	1/2	43.5	36.1	17.7	15.3	4.8	19.0	14.5	14	27	6,550
DM8FCRG4	8	1/4	38.5	31.0	18.6	16.2	5.5	13.0	9.5	16	19	7,750
DM8FCRG6	8	3/8	36.2	28.7	18.6	16.2	6.5	14.0	10.0	16	24	7,750
DM8FCRG8	8	1/2	41.0	33.5	18.6	16.2	7.0	19.0	14.5	16	27	6,550
DM10FCRG4	10	1/4	39.4	31.8	19.5	17.2	5.5	13.0	9.5	19	19	9,150
DM10FCRG6	10	3/8	38.8	31.2	19.5	17.2	6.5	14.0	10.0	19	24	7,750
DM10FCRG8	10	1/2	42.1	34.5	19.5	17.2	7.0	19.0	14.5	19	27	6,550
DM12FCRG4	12	1/4	41.9	31.8	22.0	22.8	5.5	13.0	9.5	22	22	9,300
DM12FCRG6	12	3/8	44.4	34.3	22.0	22.8	6.5	14.0	10.0	22	24	7,750
DM12FCRG8	12	1/2	48.2	38.1	22.0	22.8	7.0	19.0	14.5	22	27	6,550
DM20FCRG8	20	1/2	54.3	44.2	22.0	26.0	7.0	19.0	14.5	32	30	6,550
DM22FCRG8	22	1/2	54.3	44.2	22.0	26.0	7.0	19.0	14.5	32	30	4,550

NOTE: No Seal is made with the mating male thread. Instead, a RG gasket is placed in the flat bottom of the female end and the end of the mating male thread compresses against the RG gasket to seal.

RG Fitting Gasket (RG)

Duolok Part #	E	A	L
4RG-CU	7.6	10.7	1.8
6RG-CU	8.6	14.2	2.3
8RG-CU	9.1	17.8	2.5



Finger-tight assembly dimensions (shown in millimeters) are for reference only and subject to change.
 Code Pressures per ASME B31.3 Refer to *Selection Guide for Instrumentation Tubing for Working Pressures*.
 Visit www.sspittings.com for controlled version of data.

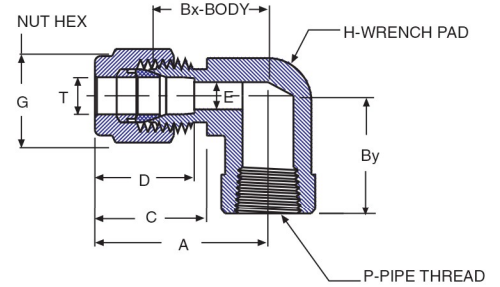
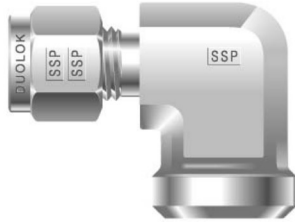

Female Elbow - NPT (FE)

Duolok Part #	T TUBE O.D.	P NPT FEMALE PIPE	A	Bx	By	C	D	E Minimum Opening	G	H (inch)	Code Pressure (psig)
DM6FE2	6	1/8	27.0	19.6	19.0	17.7	15.3	4.8	14	1/2	8,300
DM6FE4	6	1/4	29.8	22.4	22.4	17.7	15.3	4.8	14	11/16	6,150
DM6FE8	6	1/2	34.6	27.2	28.4	17.7	15.3	4.8	14	1	5,500
DM8FE4	8	1/4	30.6	23.1	22.4	18.6	16.2	6.4	16	11/16	6,150
DM10FE2	10	1/8	31.5	23.9	19.0	19.5	17.2	7.9	19	11/16	8,300
DM10FE4	10	1/4	33.5	25.9	22.4	19.5	17.2	7.9	19	13/16	8,800
DM12FE4	12	1/4	36.0	25.9	22.4	22.0	22.8	9.5	22	13/16	8,800
DM12FE8	12	1/2	38.8	28.7	28.4	22.0	22.8	9.5	22	1	-
DM16FE8	16	1/2	39.5	29.7	28.4	22.0	24.4	12.7	25	1-1/16	5,900

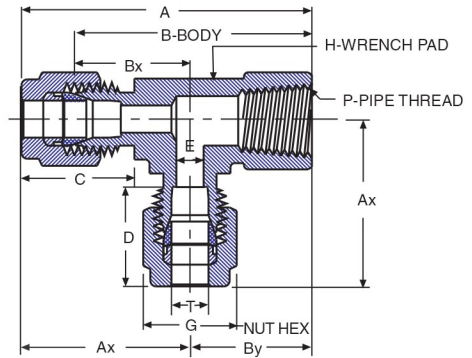
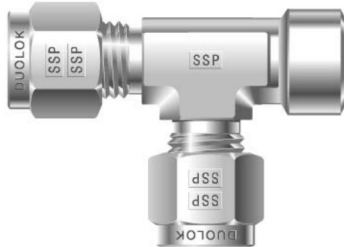

Female Run Tee - NPT (FRT)

Duolok Part #	T TUBE O.D.	P NPT FEMALE PIPE	A	AX	B	Bx	By	C	D	E Minimum Opening	G	H (inch)	Code Pressure (psig)
DM6FRT2	6	1/8	46.0	27.0	38.6	19.6	19.0	17.7	15.3	4.8	14	1/2	8,600
DM6FRT4	6	1/4	52.1	29.8	44.7	22.4	22.4	17.7	15.3	4.8	14	3/4	8,800
DM8FRT2	8	1/8	48.9	29.9	41.4	22.4	19.0	18.6	16.2	6.4	16	5/8	7,750
DM8FRT4	8	1/4	53.0	30.6	45.5	23.1	22.4	18.6	16.2	6.4	16	3/4	7,750
DM10FRT4	10	1/4	55.9	33.5	48.3	25.9	22.4	19.5	17.2	7.9	19	13/16	8,800
DM12FRT4	12	1/4	58.4	36.0	48.3	25.9	22.4	22.0	22.8	9.5	22	13/16	8,800
DM12FRT6	12	3/8	58.4	36.0	48.3	25.9	22.4	22.0	22.8	10.3	22	13/16	5,800
DM16FRT8	16	1/2	68.2	39.8	58.1	29.7	28.4	22.0	24.4	12.7	25	1-1/16	5,900

Finger-tight assembly dimensions (shown in millimeters) are for reference only and subject to change.
 Code Pressures per ASME B31.3 Refer to *Selection Guide for Instrumentation Tubing for Working Pressures*.
 Visit www.sspfittings.com for controlled version of data.

Tube to Female Pipe/Tube to Tube Union

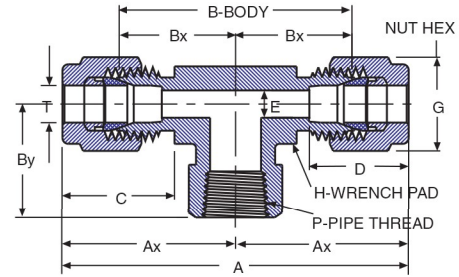

Female Branch Tee - NPT (FBT)

Duolok Part #	T TUBE O.D.	P NPT FEMALE PIPE	A	Ax	B	Bx	By	C	D	E Minimum Opening	G	H (inch)	Code Pressure (psig)
DM6FBT4	6	1/4	59.5	29.8	44.7	22.4	22.4	17.7	15.3	4.8	14	3/4	8,800
DM8FBT2	8	1/8	59.7	29.9	44.7	22.4	19.0	18.6	16.2	6.4	16	5/8	7,750
DM8FBT4	8	1/4	61.2	30.6	46.2	23.1	22.4	18.6	16.2	6.4	16	3/4	7,750
DM10FBT4	10	1/4	67.0	33.5	51.8	25.9	22.4	19.5	17.2	7.9	19	13/16	8,800
DM12FBT4	12	1/4	72.0	36.0	51.8	25.9	22.4	22.0	22.8	9.5	22	13/16	8,800
DM12FBT6	12	3/8	72.0	36.0	51.8	25.9	22.4	22.0	22.8	9.5	22	13/16	5,800
DM16FBT8	16	1/2	77.6	38.8	57.4	28.7	28.4	22.0	24.4	12.7	25	1	5,900

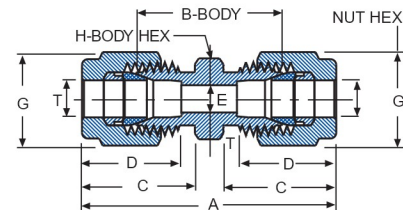
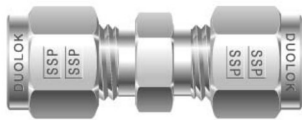

Union (U)

Duolok Part #	T TUBE O.D.	A	B	C	D	E Minimum Opening	G	H	Code Pressure (psig)
DM3U	3	35.3	22.1	15.3	12.9	2.4	12	12	28,100
DM4U	4	37.3	24.1	16.1	13.7	2.4	12	12	24,550
DM6U	6	41.0	26.2	17.7	15.3	4.8	14	14	12,800
DM8U	8	43.2	28.2	18.6	16.2	6.4	16	15	7,750
DM10U	10	46.2	31.0	19.5	17.2	7.9	19	18	9,150
DM12U	12	51.2	31.0	22.0	22.8	9.5	22	22	10,200
DM14U	14	52.0	31.8	22.0	24.4	11.1	25	24	10,750
DM15U	15	52.0	31.8	22.0	24.4	11.9	25	24	8,050
DM16U	16	52.0	31.8	22.0	24.4	12.7	25	24	5,900
DM18U	18	53.5	33.3	22.0	24.4	15.1	30	27	6,800
DM20U	20	55.0	34.8	22.0	26.0	15.9	32	30	7,600
DM22U	22	55.0	34.8	22.0	26.0	18.3	32	30	4,550
DM25U	25	65.0	40.4	26.5	31.3	21.8	38	35	5,650

Finger-tight assembly dimensions (shown in millimeters) are for reference only and subject to change.

Code Pressures per ASME B31.3 Refer to *Selection Guide for Instrumentation Tubing for Working Pressures*.

Visit www.ssp fittings.com for controlled version of data.

Tube to Tube Union

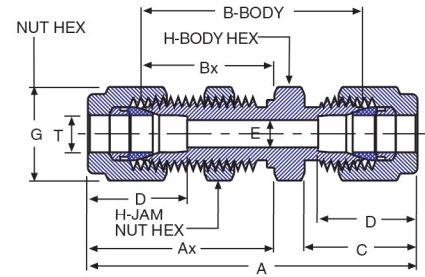
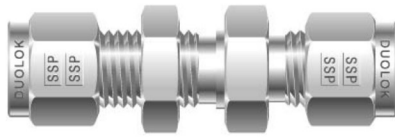

Bulkhead Union (BU)

Duolok Part #	T TUBE O.D.	A	Ax	B	Bx	C	D	E Minimum Opening	G	H	PANNEL HOLE DRILL SIZE	MAXIMUM PANNEL THICKNESS	Code Pressure (psig)
DM3BU	3	51.3	31.2	38.1	24.6	15.3	12.9	2.4	12	14	8.3	12.7	28,100
DM4BU	4	53.6	32.0	40.4	25.4	16.1	13.7	2.4	12	14	9.9	12.7	24,550
DM6BU	6	57.7	33.6	42.9	26.2	17.7	15.3	4.8	14	16	11.5	10.2	12,800
DM8BU	8	61.0	36.1	46.0	28.6	18.6	16.2	6.4	16	18	13.1	11.2	7,750
DM10BU	10	63.7	37.0	48.5	29.4	19.5	17.2	7.9	19	22	16.3	11.2	9,150
DM12BU	12	71.0	41.9	50.8	31.8	22.0	22.8	9.5	22	24	19.5	12.7	10,200
DM14BU	14	72.5	42.6	52.3	32.5	22.0	24.4	11.1	25	27	22.5	12.7	10,750
DM15BU	15	72.5	42.6	52.3	32.5	22.0	24.4	11.9	25	27	22.8	12.7	8,050
DM16BU	16	72.5	42.6	52.3	32.5	22.0	24.4	12.7	25	27	22.8	12.7	5,900
DM18BU	18	78.9	47.4	58.7	37.3	22.0	24.4	15.1	30	30	26.0	16.8	6,800
DM20BU	20	84.5	53.0	64.3	42.9	22.0	26.0	15.9	32	35	29.0	19.0	7,600

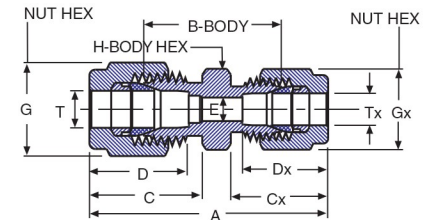
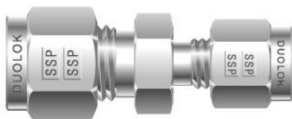

Reducing Union (RU)

Duolok Part #	T TUBE O.D.	TX TUBE O.D.	A	B	C	Cx	D	Dx	E Minimum Opening	G	Gx	H	Code Pressure (psig)
DM6RUM3	6	3	38.6	24.6	17.7	15.3	15.3	12.9	2.4	14	12	14	12,800
DM6RUM4	6	4	39.4	25.4	17.7	16.1	15.3	13.7	2.4	14	12	14	12,800
DM8RUM6	8	6	42.3	27.4	18.6	17.7	16.2	15.3	4.8	16	14	15	7,750
DM10RUM6	10	6	44.5	29.5	19.5	17.7	17.2	15.3	4.8	19	14	18	9,150
DM10RUM8	10	8	45.1	30.0	19.5	18.6	17.2	16.2	6.4	19	16	18	7,750
DM12RUM6	12	6	47.0	29.5	22.0	17.7	22.8	15.3	4.8	22	14	22	10,200
DM12RUM8	12	8	47.8	30.2	22.0	18.6	22.8	16.2	6.4	22	16	22	7,750
DM12RUM10	12	10	48.7	31.0	22.0	19.5	22.8	17.2	7.9	22	19	22	9,150
DM16RUM10	16	10	49.5	31.8	22.0	19.5	24.4	17.2	7.9	25	19	24	5,900
DM16RUM12	16	12	52.0	31.8	22.0	22.0	24.4	22.8	9.5	25	22	24	5,900
DM18RUM12	18	12	53.5	33.3	22.0	22.0	24.4	22.8	9.5	30	22	27	6,800
DM25RUM18	25	18	61.0	38.6	26.5	22.0	31.3	24.4	15.1	38	30	35	5,650
DM25RUM20	25	20	62.3	39.9	26.5	22.0	31.3	26.0	15.9	38	32	35	5,650

Finger-tight assembly dimensions (shown in millimeters) are for reference only and subject to change.
 Code Pressures per ASME B31.3 Refer to *Selection Guide for Instrumentation Tubing for Working Pressures*.
 Visit www.sspfittings.com for controlled version of data.

Tube to Tube Union

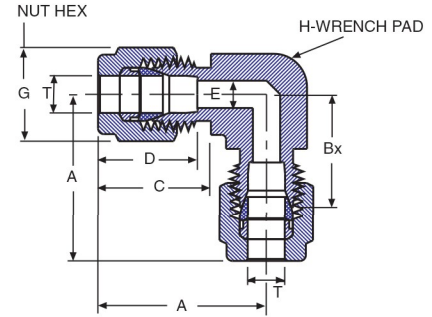

Union Elbow (UE)

Duolok Part #	T TUBE O.D.	A	Bx	C	D	E Minimum Opening	G	H (inch)	Code Pressure (psig)
DM3UE	3	22.3	15.7	15.3	12.9	2.4	12	3/8	28,100
DM4UE	4	25.4	18.8	16.1	13.7	2.4	12	1/2	24,550
DM6UE	6	27.0	19.6	17.7	15.3	4.8	14	1/2	12,800
DM8UE	8	28.8	21.3	18.8	16.2	6.4	16	9/16	7,750
DM10UE	10	31.5	23.9	19.5	17.2	7.9	19	11/16	9,150
DM12UE	12	36.0	25.9	22.0	22.8	9.5	22	13/16	10,200
DM14UE	14	38.0	27.9	22.0	24.4	11.1	25	15/16	10,750
DM15UE	15	38.0	27.9	22.0	24.4	11.9	25	15/16	8,050
DM16UE	16	38.0	27.9	22.0	24.4	12.7	25	15/16	5,900
DM18UE	18	39.8	29.7	22.0	24.4	15.1	30	1-1/16	6,800
DM20UE	20	44.6	34.5	22.0	26.0	15.9	32	1 3/8	7,600
DM22UE	22	44.6	34.5	22.0	26.0	18.3	32	1 3/8	4,550
DM25UE	25	49.1	36.8	26.5	31.3	21.8	38	1 3/8	5,650

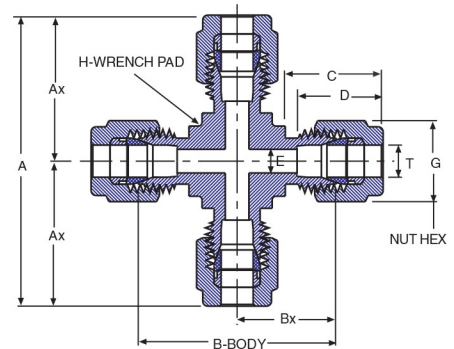

Union Cross (UCS)

Duolok Part #	T TUBE O.D.	A	Ax	B	Bx	C	D	E Minimum Opening	G	H (inch)	Code Pressure (psig)
DM3UCS	3	44.7	22.3	31.5	15.7	15.3	12.9	2.4	12	3/8	28,100
DM6UCS	6	53.9	27.0	39.1	19.6	17.7	15.3	4.8	14	1/2	12,800
DM8UCS	8	59.7	29.9	44.7	22.4	18.6	16.2	6.4	16	5/8	7,750
DM10UCS	10	67.0	33.5	51.8	25.9	19.5	17.2	7.9	19	13/16	9,150
DM12UCS	12	72.0	36.0	51.8	25.9	22.0	22.8	9.5	22	13/16	10,200
DM16UCS	16	74.0	37.0	53.8	26.9	22.0	24.4	12.7	25	15/16	5,900
DM18UCS	18	76.6	38.3	56.4	28.2	22.0	24.4	15.1	30	1-1/16	6,800
DM20UCS	20	89.3	44.6	69.1	34.5	22.0	26.0	15.9	32	1-3/8	7,600
DM25UCS	25	98.3	49.1	73.7	36.8	26.5	31.3	21.8	38	1-3/8	5,650

Finger-tight assembly dimensions (shown in millimeters) are for reference only and subject to change.
 Code Pressures per ASME B31.3 Refer to *Selection Guide for Instrumentation Tubing for Working Pressures*.
 Visit www.sspittings.com for controlled version of data.

Tube to Tube Union

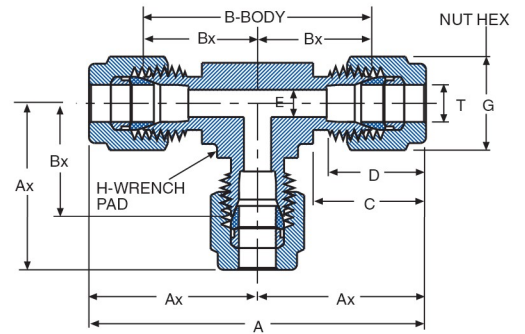
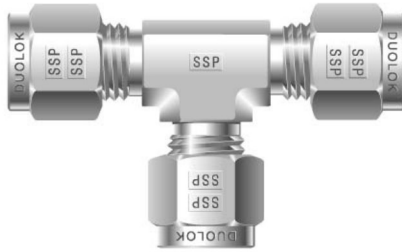

Union Tee (UT)

Duolok Part #	T TUBE O.D.	A	AX	B	Bx	C	D	E Minimum Opening	G	H (inch)	Code Pressure (psig)
DM3UT	3	44.7	22.3	31.5	15.7	15.3	12.9	2.4	12	3/8	28,100
DM4UT	4	50.8	25.4	37.6	18.8	16.1	13.7	2.4	12	1/2	24,550
DM6UT	6	53.9	27.0	39.1	19.6	17.7	15.3	4.8	14	1/2	12,800
DM8UT	8	59.7	29.9	44.7	22.4	18.6	16.2	6.4	16	5/8	7,750
DM10UT	10	63.0	31.5	47.8	23.9	19.5	17.2	7.9	19	11/16	9,150
DM12UT	12	72.0	36.0	51.8	25.9	22.0	22.8	9.5	22	13/16	10,200
DM14UT	14	77.6	38.8	57.4	28.7	22.0	24.4	11.1	25	1	10,750
DM15UT	15	77.6	38.8	57.4	28.7	22.0	24.4	11.9	25	1	8,050
DM16UT	16	77.6	38.8	57.4	28.7	22.0	24.4	12.7	25	1	5,900
DM18UT	18	79.5	38.8	59.4	29.7	22.0	24.4	15.1	30	1-1/16	6,800
DM20UT	20	89.3	44.6	69.1	34.5	22.0	26.0	15.9	32	1-3/8	7,600
DM22UT	22	89.3	44.6	69.1	34.5	22.0	26.0	18.3	32	1-3/8	4,550
DM25UT	25	98.3	49.1	73.7	36.8	26.5	31.3	21.8	38	1-3/8	5,650

Finger-tight assembly dimensions (shown in millimeters) are for reference only and subject to change.
 Code Pressures per ASME B31.3 Refer to *Selection Guide for Instrumentation Tubing for Working Pressures*.
 Visit www.sspittings.com for controlled version of data.

Tube to Welded System

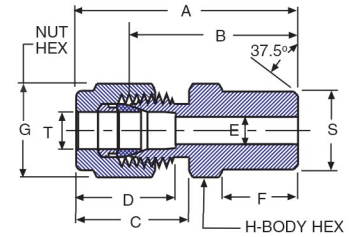

Male Pipe Weld Connector (MPWC)

Duolok Part #	T TUBE O.D.	MALE PIPE WELD SIZE	A	B	C	D	E Minimum Opening	F	G	H	S	Code Pressure (psig)
DM3MPWC2	3	1/8	30.5	23.9	15.3	12.9	2.4	9.7	12	12	10.3	9,350
DM4MPWC2	4	1/8	31.2	24.6	16.1	13.7	2.4	9.7	12	12	10.3	9,350
DM6MPWC2	6	1/8	32.8	25.4	17.7	15.3	4.8	9.7	14	14	10.3	9,350
DM6MPWC4	6	1/4	37.9	30.5	17.7	15.3	4.8	14.2	14	14	13.7	8,800
DM8MPWC2	8	1/8	34.2	26.7	18.6	16.2	5.1	9.7	16	15	10.3	7,750
DM8MPWC4	8	1/4	38.7	31.2	18.6	16.2	6.4	14.2	16	15	13.7	7,750
DM8MPWC8	8	1/2	45.6	38.1	18.6	16.2	6.4	19.0	16	22	21.3	7,750
DM10MPWC4	10	1/4	40.9	33.3	19.5	17.2	7.1	14.2	19	18	13.7	8,800
DM10MPWC6	10	3/8	40.9	33.3	19.5	17.2	7.9	14.2	19	18	17.1	7,300
DM10MPWC8	10	1/2	46.5	38.9	19.5	17.2	7.9	19.0	19	22	21.3	9,150
DM12MPWC4	12	1/4	43.4	33.3	22.0	22.8	7.1	14.2	22	22	13.7	8,800
DM12MPWC6	12	3/8	43.4	33.3	22.0	22.8	9.5	14.2	22	22	17.1	7,300
DM12MPWC8	12	1/2	49.0	38.9	22.0	22.8	9.5	19.0	22	22	21.3	10,200
DM14MPWC6	14	3/8	44.1	34.0	22.0	24.4	10.3	14.2	25	24	17.1	7,300
DM15MPWC8	15	1/2	49.0	38.9	22.0	24.4	11.9	19.0	25	24	21.3	8,050
DM16MPWC8	16	1/2	49.0	38.9	22.0	24.4	12.7	19.0	25	24	21.3	5,900
DM18MPWC8	18	1/2	50.5	40.4	22.0	24.4	13.4	19.0	30	27	21.3	6,800

Duolok tube fittings with weld ends allow weld system connection to tubing with the advantage of a leak tight seal that can be disassembled in an otherwise permanently welded system. Weld ends conform to ANSI B31.1 and B31.3 piping codes.

Welding precautions: Prior to welding, remove the nut and ferrules. To protect the fitting body threads and seat, cover with a plug or another nut. Position a suitable heat sink to dissipate the heat. Insert the tube until bottomed out in the socket, then back out approximately 1.5mm - 2.0mm before welding.

Note: The welding of a bottomed tube may lead to stress cracking of the weld. To hold the fitting in proper alignment, tack weld the fitting in four places (90° apart) and then complete the weld. After welding, remove the protective plug or nut and replace with the nut and ferrules for tube installation following the instructions from page 6.

Tube Stub Connectors/Adapters

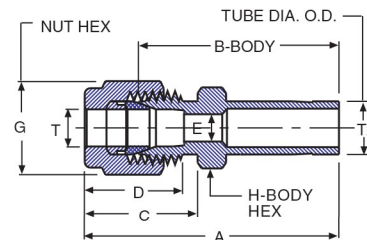
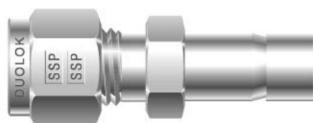

Reducer/Adapter (R)

Duolok Part #	T Tube O.D.	Tx Tube O.D.	A	B	C	D	E Minimum Opening	G	H	Code Pressure (psig)
DM3RM4	3	4	35.0	28.4	15.3	12.9	2.4	12	12	8,050
DM3RM6	3	6	36.1	32.5	15.3	12.9	2.4	12	12	10,950
DM3RM10	3	10	38.4	33.8	15.3	12.9	2.4	12	14	8,450
DM4RM6	4	6	37.1	33.3	16.1	13.7	2.4	14	12	10,950
DM6RM3	6	3	36.9	31.8	17.7	15.3	1.9	14	14	10,250
DM6RM8	6	8	39.6	35.3	17.7	15.3	4.8	14	14	7,700
DM6RM10	6	10	40.7	53.3	17.7	15.3	4.8	14	14	8,450
DM6RM12	6	12	46.3	40.6	17.7	15.3	4.8	14	14	7,000
DM6RM18	6	18	49.6	42.2	17.7	15.3	4.8	16	22	6,400
DM8RM6	8	6	40.3	35.1	18.6	16.2	4.1	16	15	7,750
DM8RM10	8	10	42.0	36.6	18.6	16.2	6.4	16	15	7,750
DM8RM12	8	12	47.6	41.9	18.6	16.2	6.4	19	15	7,000
DM10RM6	10	6	42.4	37.1	19.5	17.2	4.1	19	18	9,150
DM10RM8	10	8	43.4	38.4	19.5	17.2	5.6	19	18	7,700
DM10RM12	10	12	49.8	43.2	19.5	17.2	7.9	19	18	7,000
DM10RM15	10	15	51.3	44.5	19.5	17.2	7.9	19	18	6,800
DM10RM18	10	18	51.3	44.7	19.5	17.2	7.9	22	22	6,400
DM12RM6	12	6	44.9	36.8	22.0	22.8	4.1	22	22	10,200
DM12RM8	12	8	45.9	38.1	22.0	22.8	5.6	22	22	7,700
DM12RM10	12	10	46.7	38.4	22.0	22.8	7.1	22	22	8,450
DM12RM16	12	16	53.8	45.7	22.0	22.8	9.5	22	22	6,750
DM12RM18	12	18	53.8	45.7	22.0	22.8	9.5	22	22	6,400
DM12RM20	12	20	56.1	46.0	22.0	22.8	9.5	22	22	5,700
DM12RM22	12	22	56.1	47.5	22.0	22.8	9.5	22	24	4,400
DM12RM25	12	25	62.4	52.8	22.0	22.8	9.5	22	27	4,700
DM16RM12	16	12	53.0	44.2	22.0	24.4	8.8	25	24	5,900
DM18RM12	18	12	54.6	44.5	22.0	24.4	8.8	30	27	6,800
DM18RM16	18	16	56.1	46.0	22.0	24.4	12.0	30	27	6,750
DM18RM20	18	20	57.6	47.5	22.0	24.4	15.1	30	27	5,700
DM18RM22	18	22	57.6	47.5	22.0	24.4	15.1	30	27	4,400
DM18RM25	18	25	62.4	52.3	22.0	24.4	15.1	30	27	4,700
DM20RM16	20	16	57.9	47.8	22.0	26.0	12.0	32	30	6,750
DM20RM18	20	18	57.9	47.8	22.0	26.0	13.9	32	30	6,400
DM20RM22	20	22	59.4	49.3	22.0	26.0	15.9	32	30	4,400
DM20RM25	20	25	64.2	54.1	22.0	26.0	15.9	32	30	4,700
DM22RM18	22	18	57.9	47.8	22.0	26.0	13.9	32	30	4,550
DM22RM20	22	20	59.4	49.3	22.0	26.0	15.5	32	30	4,550
DM22RM25	22	25	64.2	54.1	22.0	26.0	18.3	32	30	4,550
DM25RM18	25	18	63.1	50.8	26.5	31.3	13.9	38	35	5,650
DM25RM20	25	20	64.6	52.3	26.5	31.3	15.5	38	35	5,650

Finger-tight assembly dimensions (shown in millimeters) are for reference only and subject to change.
 Code Pressures per ASME B31.3 Refer to *Selection Guide for Instrumentation Tubing for Working Pressures*.
 Visit www.sspfittings.com for controlled version of data.

Tube Stub Connectors/Adapters

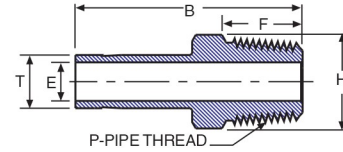
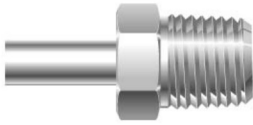

Male Adapter - NPT (MA)

Duolok Part #	T TUBE O.D.	P NPT MALE PIPE	B	E Minimum Opening	F	H (inch)	Code Pressure (psig)
DM6MA2	6	1/8	32.8	4.6	9.7	7/16	10,100
DM6MA4	6	1/4	38.1	4.6	14.2	9/16	8,300
DM8MA4	8	1/4	39.1	6.4	14.2	9/16	7,700
DM10MA4	10	1/4	39.9	7.1	14.2	9/16	8,300
DM10MA6	10	3/8	40.6	7.7	14.2	11/16	7,850
DM10MA8	10	1/2	46.2	7.7	19.2	7/8	7,750
DM12MA4	12	1/4	46.5	7.1	14.2	5/8	7,000
DM12MA8	12	1/2	52.0	9.1	19.1	7/8	7,000

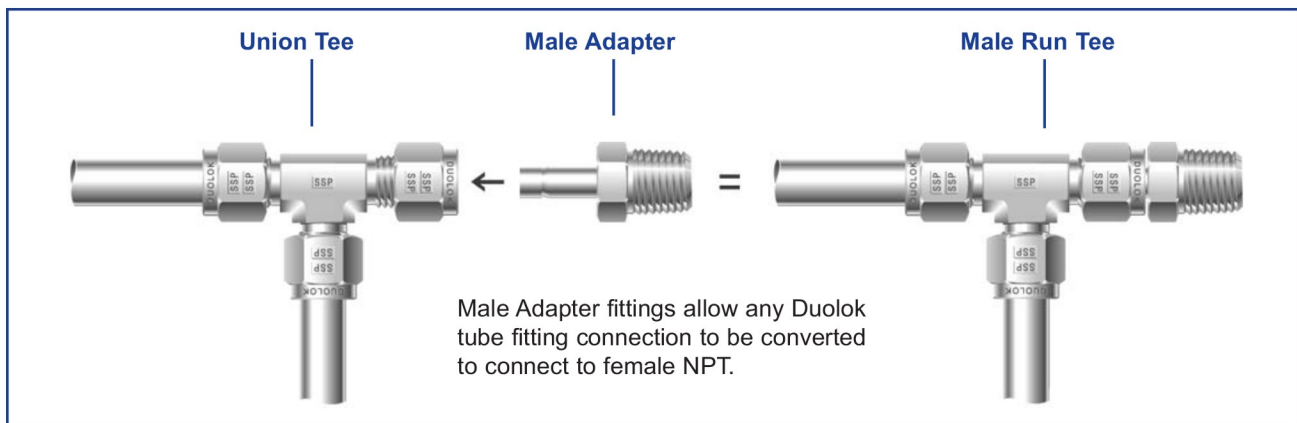

Finger-tight assembly dimensions (shown in millimeters) are for reference only and subject to change.
 Code Pressures per ASME B31.3 Refer to *Selection Guide for Instrumentation Tubing for Working Pressures*.
 Visit www.sspittings.com for controlled version of data.

Tube Stub Connectors/Adapters

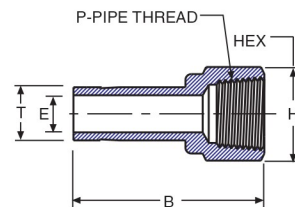

Female Adapter - NPT (FA)

Duolok Part #	T TUBE O.D.	P NPT FEMALE PIPE	B	E Minimum Opening	H	Code Pressure (psig)
DM6FA2	6	1/8	32.5	4.6	14	10,950
DM6FA4	6	1/4	37.1	4.6	19	10,850
DM8FA4	8	1/4	37.6	6.4	19	7,700
DM10FA4	10	1/4	38.1	7.7	19	7,450
DM10FA6	10	3/8	40.1	7.7	22	8,450
DM10FA8	10	1/2	46.5	7.7	27	7,350
DM12FA4	12	1/4	43.7	9.1	19	7,000
DM12FA8	12	1/2	52.3	9.1	27	7,000

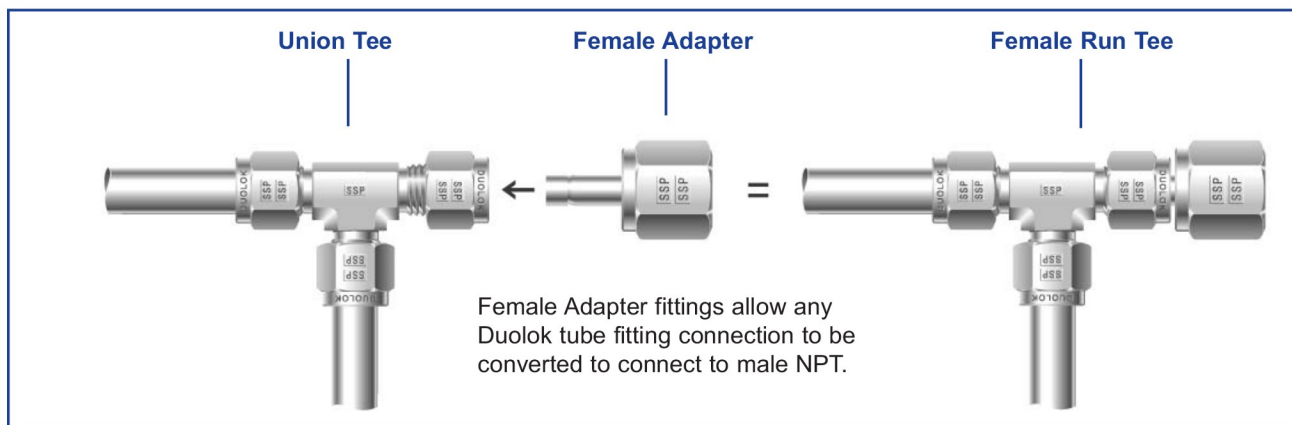

Finger-tight assembly dimensions (shown in millimeters) are for reference only and subject to change.
 Code Pressures per ASME B31.3 Refer to *Selection Guide for Instrumentation Tubing for Working Pressures*.
 Visit www.sspfittings.com for controlled version of data.

Tube Stub Connectors/Adapters

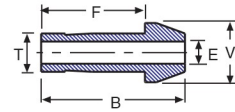

PC

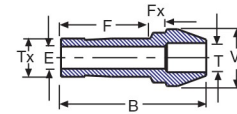

RPC

Port Connector (PC)

Duolok Part #	T TUBE O.D.	B	E Minimum Opening	F	V	Code Pressure (psig)
DM3PC	3	22.2	1.9	15.7	6.0	10,250
DM6PC	6	25.0	4.1	18.7	9.0	10,400
DM8PC	8	26.0	5.6	20.0	11.0	8,800
DM10PC	10	27.1	7.1	20.2	13.1	8,450
DM12PC	12	36.2	8.8	26.0	15.0	7,000
DM15PC	15	37.8	11.2	27.6	19.0	6,800
DM16PC	16	37.8	12.0	27.6	19.0	5,900
DM18PC	18	37.8	13.9	27.6	21.0	6,400
DM20PC	20	39.4	15.5	29.2	23.0	5,700
DM25PC	25	49.3	19.9	34.5	28.0	4,700

Reducing Port Connector (RPC)

Duolok Part #	T TUBE O.D.	Tx REDUCED TUBE O.D.	B	E Minimum Opening	F	Fx	V	Code Pressure (psig)
DM6RPCM3	6	3	22.9	1.9	13.5	3.2	9.0	10,250
DM8RPCM6	8	6	25.4	4.1	15.7	3.1	11.0	7,750
DM10RPCM6	10	6	25.8	4.1	15.7	3.4	13.1	9,150
DM10RPCM8	10	8	26.3	5.6	17.0	3.1	13.1	7,700
DM12RPCM6	12	6	29.6	4.1	15.7	3.6	15.0	10,200
DM12RPCM8	12	8	30.1	5.6	16.8	3.4	15.0	7,700
DM12RPCM10	12	10	30.6	7.1	17.5	3.1	15.0	8,450
DM16RPCM12	16	12	37.5	8.8	23.1	3.4	19.0	5,900

Port Connectors are used to close connect two Duolok tube fitting ports.

Installation Instructions for Port Connectors

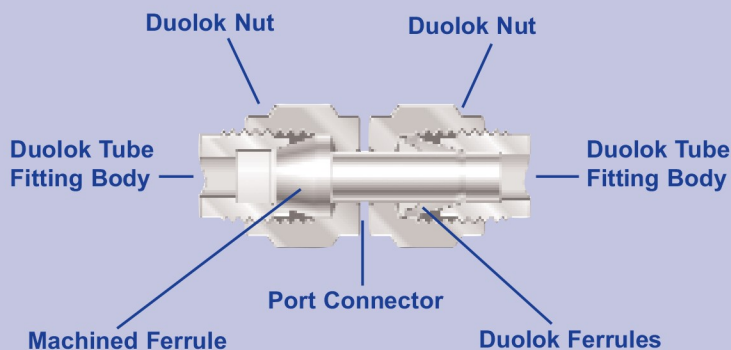

- 1A. Remove the Duolok nut and ferrules from the first of the Duolok tube fitting parts to be close connected.
- 1B. Slide the Duolok nut (no ferrules) over the machined ferrule end of the port connector.
- 1C. Insert the machined ferrule end of the port connector into the Duolok tube fitting port and hand tighten the Duolok nut.
- 1D. While holding the tube fitting body steady with a backup wrench, tighten the Duolok nut with a wrench 1/4 turn.
2. Insert opposite end of the port connector into the second tube fitting port, hand tighten the Duolok nut, and while holding the tube fitting body steady with a backup wrench; wrench tighten the Duolok nut 1-1/4 turns for sizes 6-25, and 3/4 turn for sizes 3-4.

Finger-tight assembly dimensions (shown in millimeters) are for reference only and subject to change.
 Code Pressures per ASME B31.3 Refer to *Selection Guide for Instrumentation Tubing for Working Pressures*.
 Visit www.sspfittings.com for controlled version of data.

Cap (CP)

Duolok Part #	T TUBE O.D.	A	B	C	D	G	H	Code Pressure (psig)
DM3CP	3	20.1	13.5	15.3	12.9	12	12	28,100
DM4CP	4	21.3	14.7	16.1	13.7	12	12	24,550
DM6CP	6	23.1	15.7	17.7	15.3	14	14	12,800
DM8CP	8	24.5	17.0	18.6	16.2	16	15	7,750
DM10CP	10	26.6	19.0	19.5	17.2	19	18	9,150
DM12CP	12	29.1	19.0	22.0	22.8	22	22	10,200
DM14CP	14	29.9	19.8	22.0	24.4	25	24	10,750
DM15CP	15	29.9	19.8	22.0	24.4	25	24	8,050
DM16CP	16	29.9	19.8	22.0	24.4	25	24	5,900
DM18CP	18	31.4	21.3	22.0	24.4	30	27	6,800
DM20CP	20	34.0	23.9	22.0	26.0	32	30	7,600
DM22CP	22	34.0	23.9	22.0	26.0	32	30	4,550
DM25CP	25	38.5	26.2	26.5	31.3	38	35	5,650

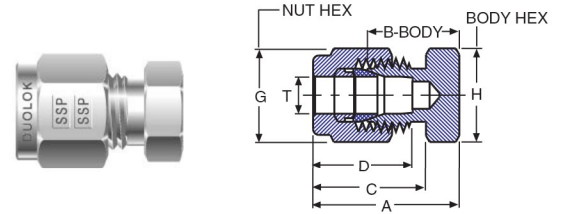

Caps are used for capping the end of a tubing run

Cap Installation Instructions

The standard Duolok tube fitting installation instructions apply for proper installation of caps (see page 6).



Plug (P)

Duolok Part #	T TUBE O.D.	G
DM3P	3	12
DM4P	4	12
DM6P	6	14
DM8P	8	16
DM10P	10	19
DM12P	12	22
DM15P	15	25
DM16P	16	25
DM18P	18	30
DM20P	20	32
DM22P	22	32
DM25P	25	38

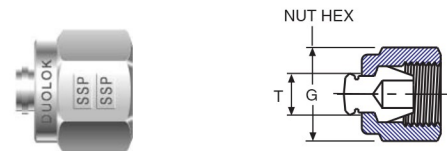

Plugs are used to plug an unused port of a Duolok tube fitting

Plug Installation Instructions

1. Remove the nut and ferrules from the port of the tube fitting body to be plugged and replace with the Duolok plug.
2. Hand-tighten the Duolok plug and then while holding the tube fitting body steady with a back-up wrench, use a wrench to tighten the Duolok plug only 1/4 of a turn.



Nut (N)

Duolok Part #	T TUBE O.D.	G	L
DM3N	3	12	11.9
DM4N	4	12	11.9
DM6N	6	14	12.7
DM8N	8	16	13.5
DM10N	10	19	15.1
DM12N	12	22	17.4
DM14N	14	25	17.4
DM15N	15	25	17.4
DM16N	16	25	17.4
DM18N	18	30	17.4
DM20N	20	32	17.4
DM22N	22	32	17.4
DM25N	25	38	20.6

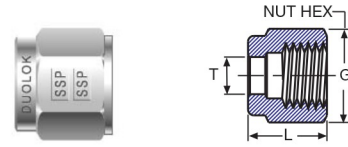

Back Ferrule (BF)

Duolok Part #	TUBE O.D.
DM3BF	3
DM4BF	4
DM6BF	6
DM8BF	8
DM10BF	10
DM12BF	12
DM14BF	14
DM15BF	15
DM16BF	16
DM18BF	18
DM20BF	20
DM22BF	22
DM25BF	25

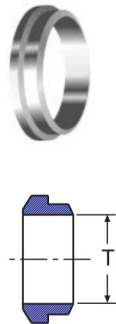

Front Ferrule (FF)

Duolok Part #	TUBE O.D.
DM3FF	3
DM4FF	4
DM6FF	6
DM8FF	8
DM10FF	10
DM12FF	12
DM14FF	14
DM15FF	15
DM16FF	16
DM18FF	18
DM20FF	20
DM22FF	22
DM25FF	25

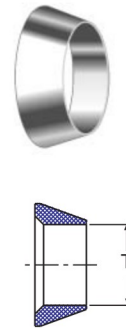

Ferrule Set (FS)

Duolok Part #	TUBE O.D.
DM6FS	6
DM8FS	8
DM10FS	10
DM12FS	12



A Ferrule Set (FS) consists of one front ferrule and one rear ferrule and is conveniently packaged and sold in multiples of ten sets per "holding tube" housing. *To order twenty (20) sets of the 1/4" 316 Stainless Steel front and back ferrules, specify: 20 pcs. ISSD4FS*

Tube Insert (TI)

Duolok Part #	TUBE O.D.	TUBE I.D.	I.D. OF BORE
DM6TI4	6	4	2.8
DM8TI6	8	6	4.4
DM10TI8	10	8	6.4
DM12TI8	12	8	6.4
DM12TI10	12	10	8.3

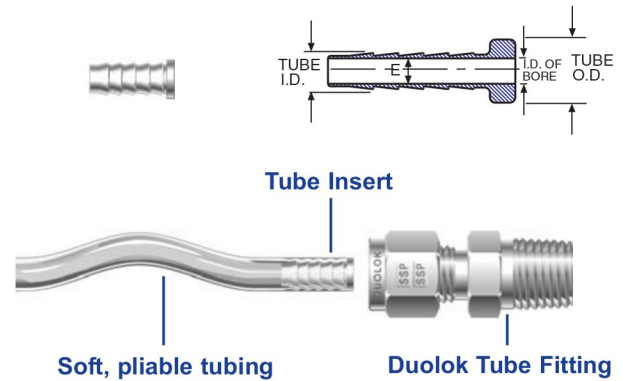

In general, Duolok tube fittings may be used with a variety of plastic tube materials without any special preparations. However, very soft-wall, pliable tubing such as Tygon[®] needs a tube insert for support prior to insertion in the Duolok tube fitting. The standard Duolok tube fitting installation instructions (see page 6) are then followed for proper make-up.

Bonded Washer (DW)

Duolok Part #	ISO PIPE SIZE	E	A	L
4DW-BSPP	1/4	13.7	20.6	2
6DW-BSPP	3/8	17.3	23.9	2
8DW-BSPP	1/2	21.6	28.7	2.5
12DW-BSPP	3/4	26.9	35.1	2.5
16DW-BSPP	1	33.8	42.9	2.5

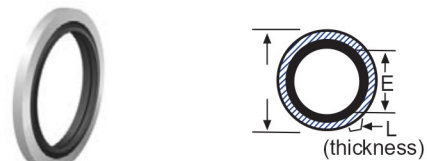

Comes standard as 300 series stainless steel washer with Buna inner ring. Also available with Viton[®] ring or as a stainless steel washer with Viton[®] ring. Add -V for Viton[®] or -SS-V for stainless steel/ Viton[®]

SSP instrumentation quality tube fittings have been designed and manufactured to provide leak free connections in a wide variety of applications. The design characteristics of the tube fittings compensate for many of the field variables involved in the installation of the tube fittings and with the tolerances, wall thickness, finish and quality of the tubing. A reliable leak free tubing system will be achieved by combining the proper selection and handling of tubing with the proper tube fitting selection and installation. The following information is provided to assist in the tube selection process.

MATERIAL

The tubing material chosen must be compatible with the system's contained media, pressure and temperature, as well as with the environment in which it will be installed. Also, the tubing and tube fitting materials should be similar for optimum sealing action to occur (stainless fittings for stainless tube, brass fittings for copper tube, carbon steel fittings for carbon steel tube, etc.) The mixing and contact of dissimilar materials may leave the system susceptible to galvanic corrosion and/or not allow proper tube fitting make up to be achieved. Additionally, the tube fittings have been designed and manufactured to function within the hardness ranges allowed for similar tubing material by applicable EN ISO 1127 specifications as referred to in Table 1.

PRESSURE AND FLOW

The size of the tube's outside diameter (O.D.) and the necessary wall thickness are determined by the systems pressure and flow requirements. Table 1 details the suggested tubing sizes and wall thicknesses for use with instrument tube fittings. Additionally, the tables provide the maximum allowable working pressures for each size of tube recommended for use with instrument tube fittings. If no pressure is shown on the table for a particular size, the tube is not recommended for use with instrumentation tube fittings. The tubing system should not be utilized above the tube's maximum allowable working pressure; however, instrument tube fittings have been tested as leak tight to the burst pressure of the tubing in all recommended sizes and wall thickness.

TEMPERATURE

The system's operating temperature may effect the initial choice of tubing material and may also effect the maximum allowable working pressure for the given tube size (see Table 2 for temperature stress factors).

LIGHT GAS SERVICE

Light gasses such as hydrogen, helium, nitrogen, etc. have extremely small molecules which can be released through the smallest of leak paths including tubing surface imperfections or defects. To provide a successful connection for light gas service, the tubing must have a thick enough wall to provide resistance for the setup action of the ferrules to further compensate for the tube's potential surface condition. Table 1 shows the tubing sizes and wall thicknesses recommended for light gas service.

HANDLING AND INSTALLATION

Surface scratches and gouges on tubing are a source of potential leaks. Some precaution when handling the tubing can help reduce surface scratches and maintain the surface finish as originally intended by the manufacturer. Tubing should never be dragged across rocks, blacktop, pavement or the tubing storage rack as scratches and gouges can occur. Sharp blades should always be used in the tube cutters or hacksaws used to cut the tubing as to provide a clean square cut. Dull cutting blades can cause internal and external hanging burrs, and cause the tubing to become oval and effect proper insertion within the fitting. As a good handling practice, tubing should always be deburred prior to tube fitting installation to help assure easy and complete tube insertion. Additionally, for bent tube assemblies, it is important to bend tubing prior to installing tube fittings, and to provide a sufficient straight length of tubing after the bend to allow the tube to be fully inserted into the fitting. See Table 4 for additional information. Also, to eliminate weight stress from the tubing upon the fitting and to provide additional system support for vibration and thermal shock resistance, the tubing should always be supported by tube hangers, clamps or trays.

STAINLESS STEEL TUBING - TABLE 1 Maximum Allowable Working Pressure (bar)											
Tube O.D. Size (mm)	Wall Thickness of Tube (mm)										
	0.8	1.0	1.2	1.5	1.8	2.0	2.2	2.5	2.8	3.0	3.5
3	670										
6	310	420	540	710							
8		310	390	520							
10		240	300	400	510	580					
12		200	250	330	410	470					
14		160	200	270	340	380	430				
15		150	190	250	310	360	400				
16			170	230	290	330	370	400			
18			150	200	260	290	320	370			
20			140	180	230	260	290	330	380		
22			140	160	200	230	260	300	340		
25					180	200	230	260	290	320	

Note: For light gas service, use tubing with wall thickness outside of screened area.

Calculation Basis: Annealed, seamless 304 or 316 stainless steel tubing EN ISO 1127 or equivalent (from ASME B31.3). System temperatures between -20°F and 100°F with allowable stress of 1370 bar (20,000 psi). Ultimate tensile strength of 5170 bar (75,000 psi). Safety factor of 4.

Reference: ANSI B31.3 Code. (For more specific working pressure information regarding a particular tubing, consult with the actual manufacturer of the tubing.) Multiply stainless steel rating by 0.94 for working pressure in accordance with ASME B31.1.

Note: For welded and drawn tubing, a derating factor must be utilized. For double welded tube, multiply the above pressure rating by .85; and for single welded tube .80. (ANSI B31 Table A-1B).

Suggested Tube Ordering Information: Specify the outside diameter and wall thickness of annealed, seamless or welded and drawn 316 or 304 stainless steel tubing of EN ISO 1127 or equivalent. Also specify high quality tubing to be free of scratches, and suited for bending with material hardness not to exceed Rb 90 (200 HV).

STRESS FACTORS FOR DETERMINING TUBING PRESSURE RATINGS AT ELEVATED TEMPERATURES - TABLE 2			
TEMPERATURE STRESS FACTORS			
Temperature		Stainless Steel	
°F	°C	304SS	316SS
100	38	1.00	1.00
200	93	1.00	1.00
300	149	1.00	1.00
400	204	.94	.97
500	260	.88	.90
600	316	.82	.85
700	371	.80	.82
800	427	.76*	.80*
900	482	.73*	.78*
1000	538	.69*	.73*
1200	649	.30*	.37*

* The precipitation of chromium carbides potentially resulting in intergranular corrosion may occur when exposed to operating temperatures above 800°F / 427°C. Consult the factory for further information.

Instructions: To determine maximum allowable working pressure for tubing at elevated temperatures, multiply the applicable tube's maximum allowable working pressure from Table 1 by the corresponding temperature stress factor from Table 2.

SSP PIPE END PRESSURE RATINGS, ANSI/ASME B 31.3 - TABLE 3					
NPT/ISO Pipe Size	Size	316 STAINLESS STEEL			
		Male		Female	
		psig	bar	psig	bar
1/16"	1	11,050	760	6,750	460
1/8"	2	10,050	690	6,550	450
1/4"	4	8,050	550	6,650	460
3/8"	6	7,850	540	5,350	370
1/2"	8	7,750	530	4,950	340
3/4"	12	7,350	510	4,650	320
1"	16	5,350	370	4,450	310

Reference: bar = .0695 X psig

To obtain ANSI/ASME B 31.1 values, multiply ANSI/ASME B 31.3 values by .94.

INSTALLING TUBE FITTINGS NEAR TUBE BENDS

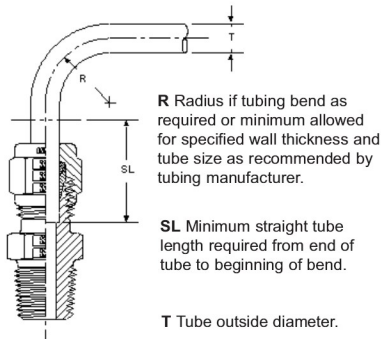

FIGURE A

When installing fittings near tube bends, it is important to **bend tubing prior to installing tube fittings** and there must be a sufficient straight length (SL) of tubing to allow the tube to be bottomed in the fitting. Note Table 4 for details.

TABLE 4

T = Tube O.D. (mm)	3	6	8	10	12	14	18	20	25
*SL= Minimum Straight Length of Tube (mm)	19	21	23	25	31	32	32	34	40
R	Radius of tube bend as recommended by bender manufacturer								

* Consult the factory on an application by application basis for variance.



IMPROPER SELECTION OR IMPROPER USE OF THE PRODUCTS DESCRIBED HEREIN OR RELATED ITEMS CAN CAUSE PERSONAL INJURY AND PROPERTY DAMAGE.

It is the sole responsibility of the system designers and users to properly select and use products for their specific applications. This document has been printed for users with technical expertise as a reference for further investigation to determine specific product needs relative to design requirements.

Safety

To help ensure the safe and reliable performance of tube fitting products, complete system design must be considered prior to the installation of the tubing and tube fittings. Determining the design compatibility of materials, media, flows, temperatures and pressures; as well as implementing proper installation, operation and maintenance of the system are the responsibility of the systems' owners, designers and users.

SSP Safety Reminders

All SSP products are designed and manufactured with safety in mind. The following is a limited list of general safety practices:

Do not install, tighten or loosen a tube fitting while the system is under pressure.

Do not loosen a tube fitting, nut or plug to relieve or bleed system pressure.

Always use a back-up wrench to hold the tube fitting body steady when tightening or loosening tube fitting nuts.

There is no need to disassemble a new tube fitting prior to use.

Use proper thread lubricants and sealants on tapered pipe threads.

Very soft, pliable plastic tubing requires a tube insert.

Tube fitting and tubing material should be similar (stainless steel fittings on stainless steel tubing, brass fittings on copper tubing, etc.) with the tubing material being fully annealed. For more specific information, refer to the Selection Guide for Instrumentation Tubing on page 32-35.

Do not weld tube fittings that assembled. Prior to welding, remove the nut and ferrules and protect the seat and thread area of the tube fitting by covering with a plug or another nut.

Duolok[®] Tube Fittings LIFETIME LIMITED WARRANTY

SSP guarantees all Duolok tube fittings and Duolok tube fitting components to be free from defects in materials and workmanship. Additionally, SSP guarantees Duolok product performance to the published catalog specifications when properly installed according to the catalog selection and installation instructions. To initiate a warranty claim, suspected defective product must be returned to SSP with the nature of potential defect documented for factory evaluation. Any product with a determined defect in material or workmanship will be replaced with an equivalent product at no charge.

This warranty comprises the sole and entire warranty pertaining to items provided hereunder. There is no other warranty, guarantee, express or implied representation of any kind whatsoever. All other warranties including, but not limited to, merchantability and fitness for purpose, whether express, implied, or arising by operation of law. Course of dealing, or trade usage are hereby disclaimed. There are no warranties which extend beyond the description on the face hereof; and this warranty does not apply in the case of abuse, mishandling, or normal use depreciation. In no event, whether alleged to arise from breach of contract, express or implied warranty, by operation of law, negligence or otherwise, will SSP be liable for any incidental, consequential, lost property, or other special damages of any kind what so ever. The exclusive only remedy under this warranty is the replacement of determined defective parts as set forth above.

Duolok[®] Metric Tube Fittings

AUTHORIZED DISTRIBUTOR:



Made in the USA

SSP
Stainless Steel Products
fittings • valves • fabrications
8250 Boyle Pkwy
Twinsburg, OH 44087-2200
P: +1.330.425.4250
F: +1.330.425.8116
www.sspfittings.com

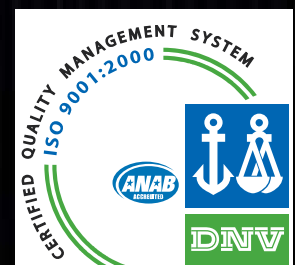

ILDMPC-/000-08A
©2008, SSP Fittings Corp.