

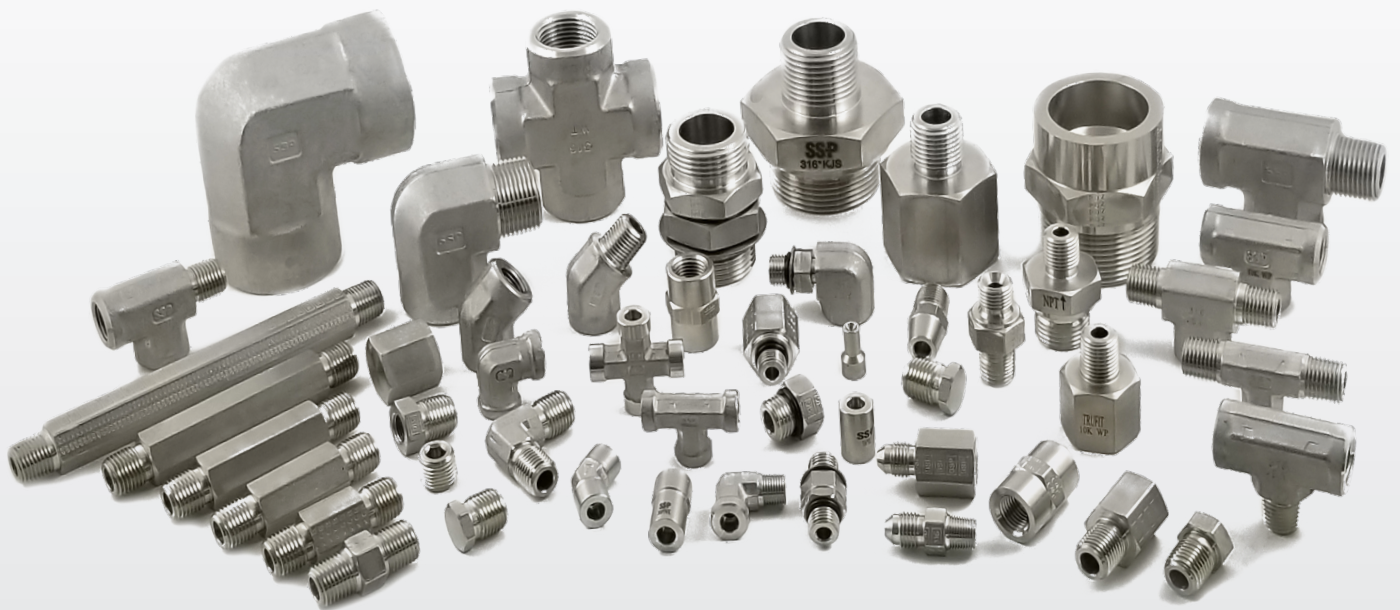

Pipe, Weld, and Adapter Fittings



TruFit® & TruFit10K® Instrumentation Fittings

- ✓ 1/16 to 2 in. sizes
- ✓ 316 SS, Alloy 400, Alloy C-276, carbon steel, and brass
- ✓ NPT, BSP, and SAE threads
- ✓ AN 37° Flared
- ✓ Tube and Pipe Socket and Butt Weld

www.mySSP.com





At SSP, we are proud to be an American manufacturing success story.

100% of our products are made in America. All of our manufacturing is performed in our 165,000 sq. ft. facility located near Cleveland, Ohio. Our facility is the largest vertically integrated, single-site operation in the industry. In addition to manufacturing and assembly, we have closed die forging, tool & die design, product engineering and testing operations under the same roof with customer service and management.

Made in America is good business. Not only do we make everything in America, we use American suppliers too. Buying American allows us to have better quality control and a more reliable supply chain. We can work more closely within our walls and with our suppliers to improve quality, reduce costs, and shorten lead times, which means faster service and better products for you.

Support where it counts. SSP products and services are supported by more than 4000 people and 350 distributor locations around the globe. For a distributor near you, contact SSP Customer Service or visit www.mySSP.com/distributors.

SSP Industry Standard Products.
Made Better.

TABLE of CONTENTS

Introduction	3	NPT Thread Fittings	12
Technical Information	4	SAE Fittings & Adapters	25
Safety.....	6	Weld Fittings and Adapters.....	28
How to Order	8	AN Flared Fittings & Adapters.....	33
Selection Guide	9	ISO / BSP Fittings & Adapters.....	37

Instrumentation Pipe Fittings

TruFit® Pipe, Weld & Adapter Fittings

SSP has been manufacturing pipe fittings for more than 75 years. TruFit instrumentation pipe fittings are manufactured with high-quality NPT, BSP, and SAE threads, AN 37° flared, and tube and pipe weld ends. Straight, elbow, tee and cross fittings can be configured with end connections from 1/16 to 2 in. TruFit pipe fittings are available in 316 stainless steel, Alloy 400, Alloy C-276 and brass. Other alloys are available on request.

TruFit10K® Fittings

SSP also offers TruFit10K fittings. Each fitting has a pressure rating of at least 10,000 psig (689 bar). They are available in 316 stainless steel in sizes from 1/16 to 1 in. NPT with BSP, SAE and AN end connections.

Product Design

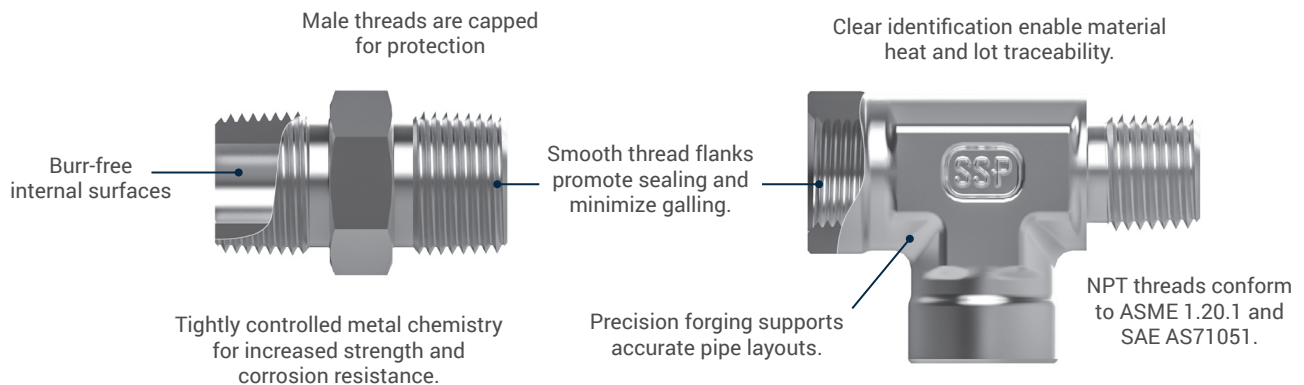

Technical Information

TruFit Pipe and Weld Fitting Applications			
Parameter	Tapered Thread	Straight Thread	Weld Ends
Pressures (ASME 31.1)	High to 10,000 psi Static systems only	High to 10,000 psi Dynamic and Static	Very High to 15000 psig Static and Dynamic
Temperatures	Stainless: -425° to 1200°F Brass: -40 to 400°F Alloy 400: -65 to 800°F	Nitrile: -30° to 250°F FKM: -15° to 400°F Copper: -315 to 400	Stainless: -425 to 1200°F
Vibration Resistance	Fair	Very Good	Excellent
Sizes	1/16 to 2 in.	#4 to #32	1/8 to 2 in.
Dynamic Temperature/Pressure	Good in static systems Poor in dynamic systems	Excellent in static systems. Very good in dynamic systems	Excellent. Permanent joints. Highly resistant to vibration
Easy of Maintenance	Limited breaks and remakes due to metal deformation of threads	Very good. Virtually unlimited remakes. O-ring replacement only	Permanently assembled

TruFit 10K Application Information		
Parameter	Tapered Thread	Straight Thread
Pressures (ASME 31.1)	10,000 psi minimum Static systems only	10,000 psi minimum Dynamic and Static Systems
Temperature Range	Stainless: -425° to 1200°F	Nitrile: -30° to 250°F FKM: -15° to 400°F
Vibration Resistance	Fair	Very Good
Size availability	1/8 to 1 in.	#4 - #16
Dynamic Temperature/Pressure	Good in static systems Poor in dynamic systems	Excellent in static systems. Very good in dynamic systems
Maintenance	Limited breaks and remakes due to metal deformation of threads	Very good. Virtually unlimited remakes. O-ring replacement only

Thread Standards

Type	Designator	Standard
NPT (Tapered)	-	ASME B1.20.1
ISO/BSP (parallel) (Based on DIN 3852)	RS	ISO 228, JIS B0202
ISO/BSP (tapered) (Based on DIN 3852)	RT	ISO 7, BS EN 10226-1, JIS B0203
Unified (SAE)	ST	ASME B1.1

Material Standards

Material	Bar	Forging
316 SS	ASTM A276, ASME SA479, EN 1.4401	ASTM A182, ASME SA182, EN 1.4401
Alloy 400	ASTM B164	ASTM B564, ASME SB564
Alloy C-276	ASTM B574	ASTM B564
Brass	ASTM B16, ASTM B453	ASTM B283
Carbon Steel	ASTM A108	-
Alloy 20	ASTM B473	ASTM B462
Alloy 600	ASTM B166, ASME SB166	ASTM B564, ASME SB564
Alloy 625	ASTM B446	ASTM B564, ASME SB564
Alloy 825	ASTM B425	ASTM B564, ASME SB564

Pressure - Temperature Ratings

Tables 1 contains typical pressure ratings for male and female NPT and BSP tapered pipe thread ends at ambient temperature. Table 2 provides pressure ratings for SAE and BSP straight pipe thread ends. Table 4 contains derating factors for determining pressure ratings for tapered fittings at higher temperatures. Table 5 lists temperature ranges for FKM and nitrile O-ring sealed ends. For more information about pressure ratings, contact SSP customer service.

NPT/ISO Pipe Size	Size	316 SS				Brass				Carbon Steel			
		Male		Female		Male		Female		Male		Female	
		psig	bar	psig	bar	psig	bar	psig	bar	psig	bar	psig	bar
1/16"	1	11,050	760	6,750	460	5,550	380	3,350	230	11,050	760	6,750	460
1/8"	2	10,050	690	6,550	450	5,050	350	3,250	220	10,050	690	6,550	450
1/4"	4	8,050	550	6,650	460	4,050	280	3,350	230	8,050	550	6,650	460
3/8"	6	7,850	540	5,350	370	3,950	270	2,650	180	7,850	540	5,350	370
1/2"	8	7,750	530	4,950	340	3,850	260	2,450	170	7,750	530	4,950	340
3/4"	12	7,350	510	4,650	320	3,650	250	2,350	160	7,350	510	4,650	320
1"	16	5,350	370	4,450	310	2,650	180	2,250	150	5,350	370	4,450	310

Reference: MPa = 0.10 x psig
To obtain ANSI/ASME B 31.1 values, multiply ANSI/ASME B 31.3 values by .94.

Size	Male		Female	
	psig	bar	psig	bar
1/8	6,000	413	5,400	380
1/4	6,000	413	5,400	373
3/8	6,000	413	5,400	373
1/2	6,000	413	4,800	331
3/4	4,800	331	4,200	290
1	3,600	248	2,400	166
1 1/4	3,000	206	2,000	138
1 1/2	2,400	166	1,800	124
2	1,800	124	1,500	104

Material	Value
316 SS	20,000 psi (1378 bar)
Brass	10,000 psi (689 bar)
Carbon Steel	20,000 psi (1378 bar)

Temperature Ratings

To determine the maximum allowable working pressure for the piping systems at elevated temperatures, multiply the applicable maximum allowable working pressure by the corresponding temperature stress factor from Table 4. System temperatures may be limited by the thread sealant or when applicable, the gasket or O-ring materials. See Table 6 for O-ring materials temperature ratings.

Temperature		Stainless Steel		Carbon Steel	Copper	Alloy 400
°F	°C	304SS	316SS			
100	38	1.00	1.00	1.00	1.00	1.00
200	93	1.00	1.00	0.96	0.80	0.88
300	149	1.00	1.00	0.90 ¹	0.78	0.82
400	204	0.94	0.97	0.86 ¹	0.50	0.79
500	260	0.88	0.90	-	-	0.79
600	316	0.82	0.85	-	-	0.79
700	371	0.80	0.82	-	-	0.79
800	427	0.76	0.80	-	-	0.76
900	482	0.73	0.78	-	-	0.43
1000	538	0.69	0.73	-	-	-
1200	649	0.30	0.37	-	-	-

¹Temperature limitation of Zinc coating (375°F) used on carbon steel fittings.

Material	Max. Temperature
316 SS	1,200 (649)
Brass	400 (204)
Carbon Steel	375 (190)

Material	Temperature Range °F (°C)
FKM	-15 to 400 (-26 to 204)
Nitrile	-30 to 250 (-34 to 121)

Safety



Important

To help ensure the safe and reliable performance of TruFit products, complete system design must be considered prior to installation of the pipe, tubing and fittings. **Determining the design compatibility of materials, media, flow, temperatures and pressures; as well as implementing proper installation, operation and maintenance of the system are the responsibilities of the systems' owner, designers and users.**

Safety Reminders

All SSP products are designed and manufactured with safety in mind. The following is a limited list of general safety tips as reminders for good safety practices:

- Do not install, tighten or loosen a fitting or adapter while the system is under pressure.
- Do not loosen a fitting, nut or plug to relieve or bleed pressure.
- Always use a back-up wrench to hold the pipe or pipe fitting body steady when tightening or loosening.
- Use proper thread lubricants and sealants on tapered pipe fittings.
- Tube fitting end connection and tubing material should be similar (stainless steel fittings on stainless steel pipe, brass fittings on copper tubing, with the tubing materials being fully annealed).
- Do not weld tube fittings that are assembled. Prior to welding, remove all components, nuts, ferrules, and seals. Protect the sealing and thread areas of the tube fitting by covering with a plug or another nut.

How to Order

The Trufit Pipe Fittings Catalog contains part numbers for the most common fitting types and sizes. Other configurations are available. To request other configurations, use the guides on pages 7 and 8 to build a part number or contact SSP customer service.

NPT Thread

Material *ISS* Brand *T* 1st End Size *4* Fitting Type *RA* 2nd End Size *2* Options *-10K*

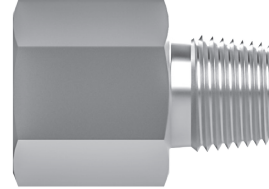

Material	
Designator	Material
IB	Brass
ISS	316 Stainless Steel
IS	Carbon Steel
IM	Alloy 400/R405
IHC	Alloy C-276

Nominal End Connection Size	
Designator	Size
1	1/16
2	1/8
4	1/4
6	3/8
8	1/2
12	3/4
16	1
20	1 1/4
24	1 1/2
32	2

Fitting Type			
Designator	Description	Designator	Description
A	Adapter	ME	Male Elbow
BT	Branch Tee	MT	Male Tee
CN	Close Nipple	PCP	Pipe Cap
E	Female Elbow	PP	Pipe Plug
E45	45° Female Elbow	PT	Pipe Tee
HCG	Hex Coupling	RA	Reducer/Adapter
HCRG	Hex Reducing Coupling	RB	Reducing Bushing
HHP	Hollow Hex Plug	SE	Street Elbow
HLN	Hex Long Nipple	RSE	Reducing Street Elbow
HN	Hex Nipple	SE45	45° Street Elbow
HRN	Hex Reducing Nipple	ST	Street Tee
MD	Mud Dauber (Vent Protector)		

Options	
Designator	Option
-10K	10K Fittings
-XP98	Per ASTM G93 Level C
-XP97	No Lube

How to Order Weld & Braze Fittings

Tube Weld, Pipe Weld Fittings and Adapters



Material Brand 1st End Size 1st Fitting Type 2nd End Size Options
 ISS T 6 TSFC 4

Nominal Size	
Designator	Size
2	1/8
3	3/16
4	1/4
5	5/16
6	3/8
8	1/2
10	5/8
12	3/4
16	1
20	1 1/4
24	1 1/2
32	2

Material	
Designator	Material
ISS	316 Stainless Steel
IM	Alloy 400
IHC	Alloy C-276

Fitting Type	
Part	Description
MPTS	Male Pipe Weld x Tube Socket Weld
MTTS	Male Tube Weld x Tube Socket Weld
TSFC	Tube Socket Female Connector
TSFE	Tube Socket Female Elbow
TSMC	Tube Socket Male Connector
TSME	Tube Socket Male Elbow
TSU	Tube Socket Union
TSUC	Tube Socket Union Cross
TSUE	Tube Socket Union Elbow
TSUT	Tube Socket Union Tee
TSWU	Tube Socket Weld Union

All Other Fittings

SAE, BSPP, BSPT, and AN 37°
Fittings and Adapters

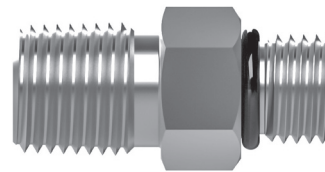

Material Brand 1st End Size 1st End Type 2nd End Size 2nd End Type Options
 ISS T 4 MST 2 MC -10K

Material	
Designator	Material
IB	Brass
ISS	316 Stainless Steel
IM	Alloy 400/R405
IHC	Alloy C-276

Options	
Designator	Option
-10K	10K Fittings
-BN	Nitrile O-ring
-V	FKM O-rings
-XP98	Clean Per ASTM G93 Level C
-XP97	No Lube

Nominal Size		
Designator	Size	SAE Thread
2	1/8	5/16-24
3	3/16	3/8-24
4	1/4	7/16-20
5	5/16	1/2-20
6	3/8	9/16-18
8	1/2	3/4-16
10	5/8	7/8-14
12	3/4	1 1/16-12
16	1	1 5/16-12
20	1 1/4	1 5/8-12
24	1 1/2	1 7/8-12
32	2	2 1/2-12



Fitting Type	
Part	Description
AN	37° Male AN
ANF	37° Female AN
CGP	Countersunk SAE Plug
FC	Female Connector
FST	Female SAE
GP	SAE Plug
ME	Male Elbow
MRS	Male BSPP
MRT	Male BSPT
MST	Male SAE

Selection Guide

Our selection guide makes it easy to locate any fitting.
Simply turn to the page designated in the lower right-hand corner.

NPT Tapered Thread

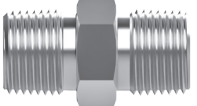
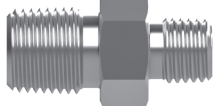

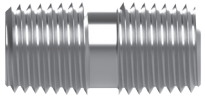
Nipples

Hex Nipple	Hex Reducing Nipple	Hex Long Nipple	Close Nipple
			
HN 12	HRN 12	HLN 13	CN 13

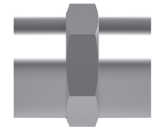
Couplings

Hex Coupling	Hex Reducing Coupling
	
HCG 14	HRCG 14

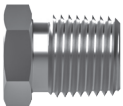
Cap & Plugs

Pipe Cap	Pipe Plug	Hollow Hex Plug
		
PCP 15	PP 15	HHP 16

Adapters

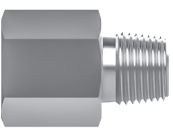
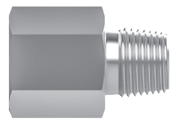
Adapter	Reducing Adapter
	
A 16	RA 17

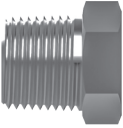

Vent Protector

Mud Dauber

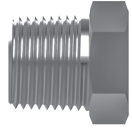
MD 17

Bushing

Reducing Bushing

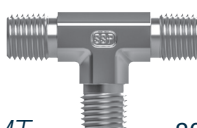
RB 18







Tee

Pipe Tee	Street Tee	Branch Tee	Male Tee
			
PT 19	ST 19	BT 20	MT 20

Cross

Pipe Cross

PCS 21

Elbow

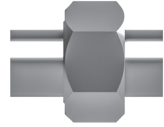

<p>Elbow</p>  <p><i>E</i> 21</p>	<p>45° Elbow</p>  <p><i>E45</i> 22</p>	<p>Male Elbow</p>  <p><i>ME</i> 22</p>
<p>Street Elbow</p>  <p><i>SE</i> 23</p>	<p>Reducing Street Elbow</p>  <p><i>RSE</i> 23</p>	<p>45° Street Elbow</p>  <p><i>SE45</i> 24</p>

Union Ball Joint

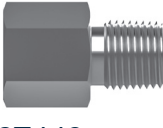
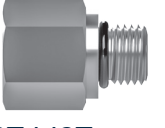
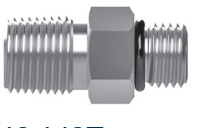

<p>Female Pipe Union</p>  <p><i>KUT</i> 24</p>
--

SAE Parallel Thread

Fittings & Adapters



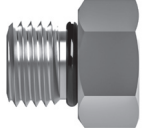

<p>Female SAE x Male NPT</p>  <p><i>FST-MC</i> 25</p>	<p>Female SAE x Male SAE</p>  <p><i>FST-MST</i> 25</p>	<p>Male SAE x Male NPT</p>  <p><i>MC-MST</i> 26</p>	<p>Male SAE x Male SAE</p>  <p><i>MST</i> 26</p>
---	--	---	---

PLUGS



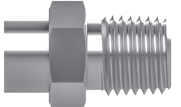

<p>Plug, SAE</p>  <p><i>GP</i> 27</p>	<p>Plug, SAE Countersunk</p>  <p><i>CGP</i> 27</p>
---	--

Weld & Braze



Tube to Pipe

Tube Socket Weld Male Connector	Tube Socket Weld Female Connector	Tube Socket Weld Male Elbow	Tube Socket Weld Female Elbow
			
TSMC 28	TSFC 28	TSME 30	TSFE 29

Tube to Tube Union





Tube Socket Weld Union	Tube Socket Weld Union Elbow	Tube Socket Weld Union Tee	Tube Socket Weld Union Cross
			
TSU 29	TSUE 30	TSUT 31	TSUC 31

Weld Adapters

Male Tube Weld x Tube Socket Weld	Male Pipe Weld x Tube Socket Weld
	
MTTS 32	MPTS 32

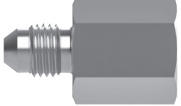
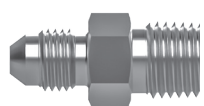
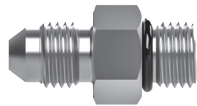
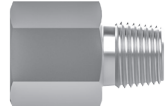
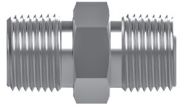
ISO/BSP Thread & AN Adapter

Adapters

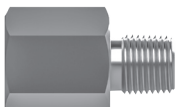
37° AN X Female NPT	37° AN X Male NPT	37° AN X Male SAE	Female NPT X Male ISO Tapered	Male NPT x Male ISO Tapered
				
AN-FC 33	AN-MC 34	AN-MST 35	FC-MRT 36	MC-MRT 36
Male NPT x Male ISO Straight	Bonded Washer	Female NPT x Male ISO Straight	Female ISO Straight X Male NPT Tapered	
				
MC-MRS 37	DW-BSPP 37	FC-MRS 38	FRS-MC 38	

HN: Hex Nipple

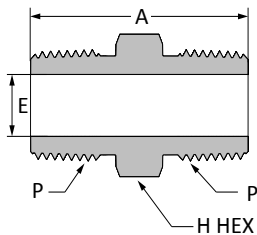
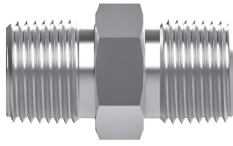

Part #	P Male NPT Size	A	E Minimum Opening	H Hex Flat	316 SS Working Pressure	Brass Working Pressure
T1HN	1/16	1.01	0.12	5/16	11,300	5,550
T2HN	1/8	1.06	0.18	7/16	10,100	5,050
T4HN	1/4	1.45	0.28	5/8	8,300	4,050
T6HN	3/8	1.45	0.40	3/4	7,850	3,950
T8HN	1/2	1.89	0.53	7/8	7,750	3,850
T12HN	3/4	1.96	0.71	1 1/8	7,350	3,650
T16HN	1	2.34	0.93	1 3/8	5,500	2,650
T20HN	1 1/4	2.48	1.25	1 3/4	6,200	-
T24HN	1 1/2	2.61	1.5	2	5,100	-
T32HN	2	2.82	1.93	2 1/2	4,000	-
TruFit 10K						
T2HN-10K	1/8	1.06	0.18	7/16	10,000	-
T4HN-10K	1/4	1.45	0.25	5/8	10,000	-
T6HN-10K	3/8	1.45	0.33	3/4	10,000	-
T8HN-10K	1/2	1.89	0.41	7/8	10,000	-
T12HN-10K	3/4	1.96	0.53	1-1/8	10,000	-
T16HN-10K	1	2.34	0.67	1-3/8	10,000	-
T32HN-10K	2	2.82	1.28	2-1/2	10,000	-

HRN Hex Reducing Nipple

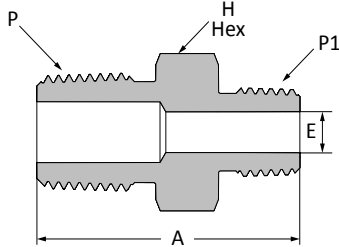
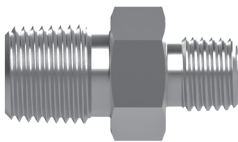

Part #	P Male NPT Size	P1 Male NPT Size	A	E Minimum Opening	H	316 SS Working Pressure	Brass Working Pressure
T2HRN1	1/8	1/16	1.03	0.11	7/16	10,100	5,050
T4HRN2	1/4	1/8	1.26	0.19	5/8	8,300	4,050
T6HRN2	3/8	1/8	1.26	0.19	3/4	7,850	3,950
T6HRN4	3/8	1/4	1.45	0.28	3/4	7,850	3,950
T8HRN2	1/2	1/8	1.51	0.19	7/8	7,750	3,850
T8HRN4	1/2	1/4	1.70	0.28	7/8	7,750	3,850
T8HRN6	1/2	3/8	1.70	0.40	7/8	7,750	3,850
T12HRN4	3/4	1/4	1.77	0.28	1 1/8	7,350	3,650
T12HRN8	3/4	1/2	1.96	0.53	1 1/8	7,350	3,650
T16HRN8	1	1/2	2.15	0.53	1 3/8	5,500	2,650
T16HRN12	1	3/4	2.15	0.71	1 3/8	5,500	2,650
T20HRN16	1 1/4	1	2.45	0.93	1 3/4	5,500	-
T24HRN16	1 1/2	1	2.55	0.93	2	5,100	-
TruFit 10K							
T4HRN2-10K	1/4	1/8	1.26	0.19	5/8	10,000	-
T6HRN2-10K	3/8	1/8	1.26	0.19	3/4	10,000	-
T6HRN4-10K	3/8	1/4	1.45	0.25	3/4	10,000	-
T8HRN2-10K	1/2	1/8	1.51	0.19	7/8	10,000	-
T8HRN4-10K	1/2	1/4	1.70	0.25	7/8	10,000	-
T8HRN6-10K	1/2	3/8	1.70	0.33	7/8	10,000	-
T12HRN4-10K	3/4	1/4	1.77	0.25	1-1/8	10,000	-
T12HRN6-10K	3/4	3/8	1.77	0.33	1-1/8	10,000	-
T12HRN8-10K	3/4	1/2	1.96	0.41	1-1/8	10,000	-
T16HRN4-10K	1	1/4	1.96	0.25	1-3/8	10,000	-
T16HRN6-10K	1	3/8	1.96	0.33	1-3/8	10,000	-
T16HRN8-10K	1	1/2	2.15	0.41	1-3/8	10,000	-
T16HRN12-10K	1	3/4	2.15	0.53	1-3/8	10,000	-

Dimensions are for reference only and are subject to change.

HLN Hex Long Nipple

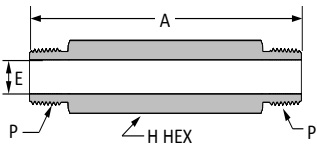

Part #	P Male NPT Size	A	E Minimum Opening	H	316 SS Working Pressure	Brass Working Pressure
T2HLN1.5	1/8	1.50	0.19	7/16	10,100	5,050
T2HLN2.0	1/8	2.00	0.19	7/16	10,100	5,050
T2HLN2.5	1/8	2.50	0.19	7/16	10,100	5,050
T2HLN3.0	1/8	3.00	0.19	7/16	10,100	5,050
T4HLN1.5	1/4	1.50	0.28	5/8	8,300	4,050
T4HLN2.0	1/4	2.00	0.28	5/8	8,300	4,050
T4HLN2.5	1/4	2.50	0.28	5/8	8,300	4,050
T4HLN3.0	1/4	3.00	0.28	5/8	8,300	4,050
T4HLN4.0	1/4	4.00	0.28	5/8	8,300	4,050
T6HLN1.5	3/8	1.50	0.40	3/4	7,850	3,950
T6HLN2.0	3/8	2.00	0.40	3/4	7,850	3,950
T6HLN2.5	3/8	2.50	0.40	3/4	7,850	3,950
T6HLN3.0	3/8	3.00	0.40	3/4	7,850	3,950
T8HLN2.0	1/2	2.00	0.53	7/8	7,750	3,850
T8HLN3.0	1/2	3.00	0.53	7/8	7,750	3,850
T8HLN4.0	1/2	4.00	0.53	7/8	7,750	3,850
T12HLN2.0	3/4	2.00	0.71	1 1/8	7,350	3,650
T12HLN3.0	3/4	3.00	0.71	1 1/8	7,350	3,650
T12HLN4.0	3/4	4.00	0.72	1 1/16	7,350	3,650
T16HLN3.0	1	3.00	0.93	1 3/8	5,500	2,650
T16HLN4.0	1	4.00	0.93	1 3/8	5,500	2,650
TruFit 10K						
T2HLN3.0-10K	1/8	3.00	0.19	7/16	10,000	-
T4HLN2.0-10K	1/4	2.00	0.25	5/8	10,000	-
T4HLN3.0-10K	1/4	3.00	0.25	5/8	10,000	-
T4HLN4.0-10K	1/4	4.00	0.25	5/8	10,000	-
T4HLN6.0-10K	1/4	6.00	0.25	5/8	10,000	-
T6HLN3.0-10K	3/8	3.00	0.33	3/4	10,000	-
T6HLN4.0-10K	3/8	4.00	0.33	3/4	10,000	-
T6HLN6.0-10K	3/8	6.00	0.33	3/4	10,000	-
T8HLN1.5-10K	1/2	1.50	0.41	7/8	10,000	-
T8HLN1.75-10K	1/2	1.75	0.41	7/8	10,000	-
T8HLN3.0-10K	1/2	3.00	0.41	7/8	10,000	-
T8HLN4.0-10K	1/2	4.00	0.41	7/8	10,000	-
T8HLN6.0-10K	1/2	6.00	0.41	7/8	10,000	-

CN Close Nipple

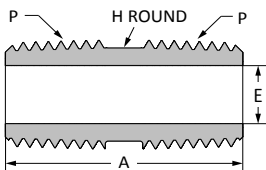
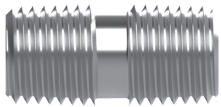

PART #	P Male NPT Size	A	E Minimum Opening	H	316 SS Working Pressure	Brass Working Pressure
T2CN	1/8	0.75	0.16	7/16	10,100	5,050
T4CN	1/4	1.13	0.25	9/16	8,300	4,050
T6CN	3/8	1.13	0.34	11/16	7,850	3,950
T8CN	1/2	1.50	0.42	7/8	7,750	3,850
T12CN	3/4	1.50	0.57	1 1/16	7,350	3,650
T16CN	1	1.88	0.84	1 3/8	5,500	2,650

Dimensions are for reference only and are subject to change.

HCG: Hex Coupling

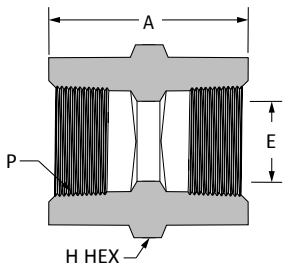
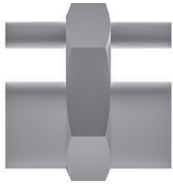

TruFit Part #	P Female NPT Size	A	E Minimum Opening	H	316 SS Working Pressure	Brass Working Pressure
T2HCG	1/8	0.75	0.34	5/8	9,250	3,250
T4HCG	1/4	1.13	0.45	3/4	7,750	3,350
T6HCG	3/8	1.13	0.59	7/8	6,800	2,650
T8HCG	1/2	1.50	0.73	1 1/8	5,950	2,450
T12HCG	3/4	1.53	0.94	1 3/8	5,600	2,350
T16HCG	1	1.89	1.17	1 5/8	5,250	2,250
T20HCG	1 1/4	1.93	1.68	2	6,350	-
T24HCG	1 1/2	1.93	1.92	2 3/8	5,600	-
T32HCG	2	1.96	2.39	2 7/8	4,650	-
TruFit 10K						
T2HCG-10K	1/8	0.75	0.33	5/8	10,000	-
T4HCG-10K	1/4	1.13	0.42	13/16	10,000	-
T6HCG-10K	3/8	1.13	0.56	1"	10,000	-
T8HCG-10K	1/2	1.50	0.69	1-1/4	10,000	-
T12HCG-10K	3/4	1.53	0.89	1-1/2	10,000	-
T16HCG-10K	1	1.89	1.13	1-7/8	10,000	-

HRCG: Hex Reducing Coupling

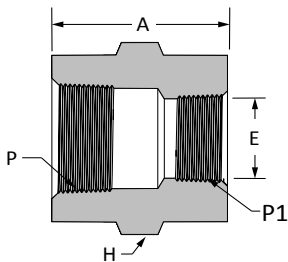
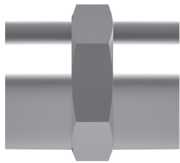

TruFit Part #	P Female NPT Size	P1 Female NPT Size	A	E Minimum Opening	H	316 SS Working Pressure	Brass Working Pressure
T4HRCG2	1/4	1/8	1.13	0.43	3/4	7,750	3,250
T6HRCG4	3/8	1/4	1.13	0.56	7/8	6,800	2,650
T8HRCG2	1/2	1/8	1.50	0.43	1 1/8	5,950	2,450
T8HRCG4	1/2	1/4	1.50	0.56	1 1/8	5,950	2,450
T8HRCG6	1/2	3/8	1.50	0.70	1 1/8	5,950	2,450
T12HRCG4	3/4	1/4	1.75	0.56	1 3/8	5,600	2,350
T12HRCG8	3/4	1/2	1.88	0.86	1 3/8	5,600	2,350
T16HRCG8	1	1/2	1.89	0.86	1 5/8	5,250	2,250
T16HRCG12	1	3/4	1.89	1.07	1 5/8	5,250	2,250
TruFit 10K							
T4HRCG2-10K	1/4	1/8	1.13	0.33	13/16	10,000	-
T6HRCG2-10K	3/8	1/8	1.13	0.33	1"	10,000	-
T6HRCG4-10K	3/8	1/4	1.13	0.42	1"	10,000	-
T8HRCG2-10K	1/2	1/8	1.50	0.33	1-1/4	10,000	-
T8HRCG4-10K	1/2	1/4	1.50	0.42	1-1/4	10,000	-
T8HRCG6-10K	1/2	3/8	1.50	0.56	1-1/4	10,000	-
T12HRCG4-10K	3/4	1/4	1.75	0.42	1-1/2	10,000	-
T12HRCG6-10K	3/4	3/8	1.75	0.56	1-1/2	10,000	-
T12HRCG8-10K	3/4	1/2	1.88	0.69	1-1/2	10,000	-
T16HRCG8-10K	1	1/2	1.89	0.69	1-7/8	10,000	-
T16HRCG12-10K	1	3/4	1.89	0.89	1-7/8	10,000	-

PCP: Pipe Cap

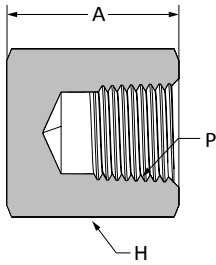

TruFit Part #	P Female NPT Size	A	H	316 SS Working Pressure	Brass Working Pressure
T2PCP	1/8	0.53	5/8	9,250	3,250
T4PCP	1/4	0.91	3/4	7,750	3,350
T6PCP	3/8	1.03	7/8	6,800	2,650
T8PCP	1/2	1.34	1 1/8	5,950	2,450
T12PCP	3/4	1.44	1 3/8	5,600	2,350
T16PCP	1	1.62	1 5/8	5,250	2,250
TruFit 10K					
T2PCP-10K	1/8	0.53	5/8	10,000	-
T4PCP-10K	1/4	0.91	13/16	10,000	-
T6PCP-10K	3/8	1.03	1	10,000	-
T8PCP-10K	1/2	1.34	1-1/4	10,000	-
T12PCP-10K	3/4	1.43	1-1/2	10,000	-
T16PCP-10K	1	1.63	1-7/8	10,000	-

PP: Pipe Plug

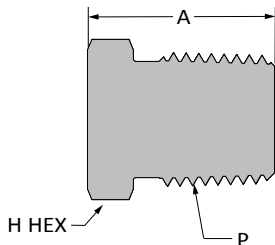
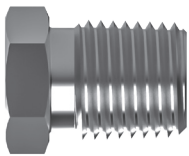

TruFit Part #	P Male NPT Size	A	H	316 SS Working Pressure	Brass Working Pressure
T1PP	1/16	0.53	3/8	11,300	5,550
T2PP	1/8	0.56	7/16	10,100	5,050
T4PP	1/4	0.74	9/16	8,300	4,050
T6PP	3/8	0.78	11/16	7,850	3,950
T8PP	1/2	0.97	7/8	7,750	3,850
T12PP	3/4	1.10	1 1/16	7,350	3,650
T16PP	1	1.24	1 5/16	5,500	2,650
T20PP	1 1/4	1.44	1 3/4	6,200	-
T24PP	1 1/2	1.50	2	5,100	-
T32PP	2	1.62	2 1/2	4,000	-
TruFit 10K					
T2PP-10K	1/8	0.56	7/16	10,000	-
T4PP-10K	1/4	0.74	9/16	10,000	-
T6PP-10K	3/8	0.78	11/16	10,000	-
T8PP-10K	1/2	0.97	7/8	10,000	-
T12PP-10K	3/4	1.10	1-1/16	10,000	-
T16PP-10K	1	1.24	1-5/16	10,000	-

Dimensions are for reference only and are subject to change.

HHP: Hollow Hex Plug

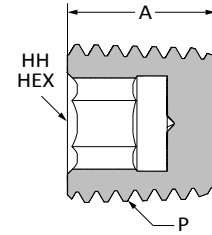
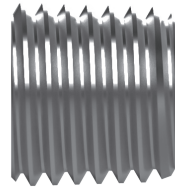

TruFit Part #	P Male NPT Size	A	HH	316 SS Working Pressure	Brass Working Pressure
T2HHP	1/8	0.30	3/16	10,100	5,050
T4HHP	1/4	0.46	1/4	8,300	4,050
T6HHP	3/8	0.46	5/16	7,850	3,950
T8HHP	1/2	0.54	3/8	7,750	-
T12HHP	3/4	0.55	9/16	7,350	-
T16HHP	1	0.69	5/8	5,500	-

A: Adapter

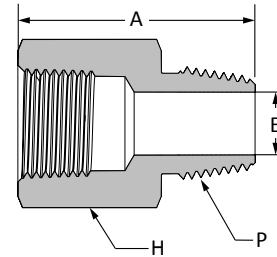
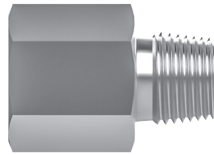

TruFit Part #	P Male & Female NPT Size	A	E Minimum Opening	H	316 SS Working Pressure	Brass Working Pressure
T2A	1/8	1.04	0.21	9/16	9,250	3,250
T4A	1/4	1.39	0.28	3/4	7,750	3,350
T6A	3/8	1.44	0.40	7/8	6,800	2,650
T8A	1/2	1.87	0.50	1 1/16	5,950	2,450
T12A	3/4	1.93	0.53	1 1/8	5,600	2,350
T16A	1	2.37	0.72	1 3/8	5,250	2,250
TruFit 10K						
T4A-10K	1/4	1.39	0.25	13/16	10,000	-
T6A-10K	3/8	1.44	0.33	1	10,000	-
T8A-10K	1/2	1.87	0.41	1-1/4	10,000	-
T12A-10K	3/4	1.93	0.53	1-1/2	10,000	-
T16A-10K	1	2.37	0.67	1-7/8	10,000	-

RA: Reducing Adapter

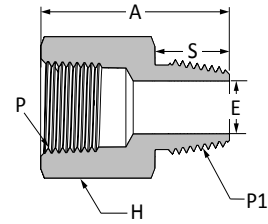
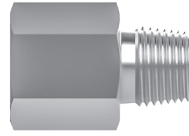

TruFit Part #	P Female NPT Size	P1 Male NPT Size	A	E Minimum Opening	H	316 SS Working Pressure	Brass Working Pressure
T2RA1	1/8	1/16	1.09	0.15	9/16	9,250	3,250
T4RA2	1/4	1/8	1.21	0.19	3/4	7,750	3,350
T6RA2	3/8	1/8	1.25	0.19	7/8	6,800	2,650
T6RA4	3/8	1/4	1.44	0.28	7/8	6,800	2,650
T8RA2	1/2	1/8	1.50	0.19	1 1/8	5,950	2,450
T8RA4	1/2	1/4	1.68	0.28	1 1/8	5,950	2,450
T8RA6	1/2	3/8	1.68	0.41	1 1/8	5,950	2,450
T12RA4	3/4	1/4	1.78	0.28	1 3/8	5,600	2,350
T12RA6	3/4	3/8	1.78	0.40	1 3/8	5,600	2,350
T12RA8	3/4	1/2	1.93	0.53	1 3/8	5,600	2,350
T16RA4	1	1/4	2.00	0.28	1 5/8	5,250	2,250
T16RA8	1	1/2	2.18	0.53	1 5/8	5,250	2,250
T16RA12	1	3/4	2.18	0.72	1 5/8	5,250	2,250
T20RA16	1 1/4	1	2.46	0.93	2	5,500	-
T24RA16	1 1/2	1	2.47	0.93	2 3/8	5,500	-
TruFit 10K							
T4RA2-10K	1/4	1/8	1.21	0.19	13/16	10,000	-
T6RA2-10K	3/8	1/8	1.25	0.19	1	10,000	-
T6RA4-10K	3/8	1/4	1.44	0.25	1	10,000	-
T8RA2-10K	1/2	1/8	1.50	0.19	1-1/4	10,000	-
T8RA4-10K	1/2	1/4	1.68	0.25	1-1/4	10,000	-
T8RA6-10K	1/2	3/8	1.68	0.33	1-1/4	10,000	-
T12RA4-10K	3/4	1/4	1.78	0.25	1-1/2	10,000	-
T12RA6-10K	3/4	3/8	1.78	0.33	1-1/2	10,000	-
T12RA8-10K	3/4	1/2	1.93	0.41	1-1/2	10,000	-
T16RA8-10K	1	1/2	2.18	0.41	1-7/8	10,000	-
T16RA12-10K	1	3/4	2.18	0.53	1-7/8	10,000	-

MD: Mud Dauber

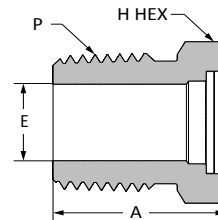
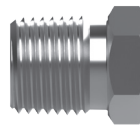

TruFit Part#	Male Pipe P-NPT	A	E	H
T2MD	1/8	0.56	0.19	9/16
T4MD	1/4	0.75	0.28	9/16
T6MD	3/8	0.78	0.37	11/16
T8MD	1/2	0.96	0.46	7/8
T12MD	3/4	1.10	0.63	1 1/16

Dimensions are for reference only and are subject to change.

RB: Reducing Bushing

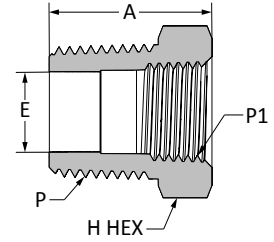
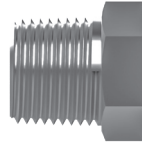

TruFit Part #	P Male NPT Size	P1 Female NPT Size	A	E Minimum Opening	H	316 SS Working Pressure	Brass Working Pressure
T2RB1	1/8	1/16	0.63	0.19	7/16	9,600	3,350
T4RB2	1/4	1/8	0.85	0.28	5/8	8,300	3,250
T6RB2	3/8	1/8	0.85	0.34	3/4	7,850	3,250
T6RB4	3/8	1/4	0.85	0.40	3/4	7,750	3,350
T8RB2	1/2	1/8	1.09	0.34	7/8	7,750	3,250
T8RB4	1/2	1/4	1.09	0.43	7/8	7,750	3,350
T8RB6	1/2	3/8	1.10	0.53	7/8	6,800	2,650
T12RB4	3/4	1/4	1.17	0.56	1 1/8	7,350	3,350
T12RB6	3/4	3/8	1.17	0.57	1 1/8	6,800	2,650
T12RB8	3/4	1/2	1.17	0.70	1 1/8	5,950	2,450
T16RB4	1	1/4	1.36	0.44	1 3/8	5,500	2,650
T16RB6	1	3/8	1.36	0.58	1 3/8	5,500	2,650
T16RB8	1	1/2	1.36	0.70	1 3/8	5,500	2,450
T16RB12	1	3/4	1.36	0.92	1 3/8	5,500	2,350
T20RB16	1 1/4	1	1.47	1.15	1 3/4	5,250	-
T24RB16	1 1/2	1	1.57	1.15	2	5,100	-
T24RB20	1 1/2	1 1/4	1.57	1.50	2	5,100	-
T32RB16	2	1	1.75	1.50	2 1/2	4,000	-
T32RB20	2	1 1/4	1.75	1.50	2 1/2	4,000	-
T32RB24	2	1 1/2	1.75	1.70	2 1/2	4,000	-
TruFit 10K							
T4RB2-10K	1/4	1/8	1.15	0.24	5/8	10,000	-
T6RB4-10K	3/8	1/4	1.38	0.32	13/16	10,000	-
T8RB2-10K	1/2	1/8	1.09	0.24	7/8	10,000	-
T8RB4-10K	1/2	1/4	1.53	0.38	7/8	10,000	-
T8RB6-10K	1/2	3/8	1.62	0.38	1"	10,000	-
T12RB4-10K	3/4	1/4	1.17	0.42	1-1/8	10,000	-
T12RB6-10K	3/4	3/8	1.59	0.50	1-1/8	10,000	-
T12RB8-10K	3/4	1/2	1.85	0.51	1-1/4	10,000	-
T16RB4-10K	1"	1/4	1.36	0.42	1-3/8	10,000	-
T16RB6-10K	1"	3/8	1.36	0.56	1-3/8	10,000	-
T16RB8-10K	1"	1/2	1.97	0.62	1-3/8	10,000	-
T16RB12-10K	1"	3/4	2.10	0.67	1-1/2	10,000	-
T32RB8-10K	2"	1/2	1.75	0.68	2-1/2	10,000	-

PT: Pipe Tee

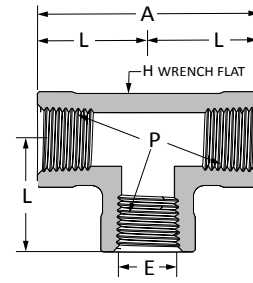

TruFit Part #	P Female NPT Size	A	E Minimum Opening	H	L	316 SS Working Pressure	Brass Working Pressure
T2PT	1/8	1.32	0.34	9/16	0.66	9,250	3,250
T4PT	1/4	1.76	0.45	3/4	0.88	7,750	3,350
T6PT	3/8	2.04	0.59	7/8	1.02	6,800	2,650
T8PT	1/2	2.46	0.73	1 1/16	1.23	5,950	2,450
T12PT	3/4	2.72	0.94	1 5/16	1.36	5,600	2,350
T16PT	1	3.24	1.17	1 5/8	1.62	5,250	2,250
T20PT	1 1/4	3.40	1.68	2	1.70	6,350	-
T24PT	1 1/2	4.16	1.92	2 3/8	2.08	5,600	-
T32PT	2	4.78	2.31	2 7/8	2.39	4,650	-
TruFit 10K							
T2PT-10K	1/8	33.5	8.3	13/16	0.66	10,000	-
T4PT-10K	1/4	44.7	10.6	3/4	0.88	10,000	-
T6PT-10K	3/8	51.8	14.2	1-1/16	1.02	10,000	-
T8PT-10K	1/2	62.4	17.5	1-5/16	1.23	10,000	-

ST: Street Tee

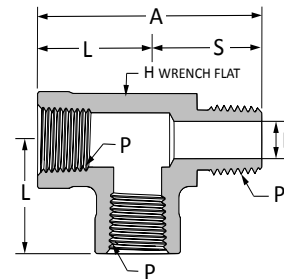

TruFit Part #	P Male & Female NPT Size	A	E Minimum Opening	H	L	S	316 SS Working Pressure	Brass Working Pressure
T2ST	1/8	1.44	0.19	9/16	0.66	0.78 (19.8)	9,250	3,250
T4ST	1/4	1.97	0.28	3/4	0.88	1.09 (27.7)	7,750	3,350
T6ST	3/8	2.24	0.40 (10.2)	7/8	1.02	1.22 (31)	6,800	2,650
T8ST	1/2	2.70	0.53 (13.5)	1 1/16	1.23	1.47 (37.3)	5,250	2,450
T12ST	3/4	2.99	0.71 (18)	1 3/8	1.38	1.61 (40.9)	5,600	-
T16ST	1	3.59	0.93 (23.6)	1 5/8	1.62	1.97 (50)	5,250	-
T20ST	1 1/4	4.08	1.25 (31.8)	2	1.70	2.38 (60.5)	6,350	-
T24ST	1 1/2	4.72	1.50 (38.1)	2 3/8	2.08	2.64 (67.1)	5,600	-
T32ST	2	5.39	1.94 (49.3)	2 7/8	2.39	3.00 (76.2)	4,650	-

Dimensions are for reference only and are subject to change.

BT: Branch Tee

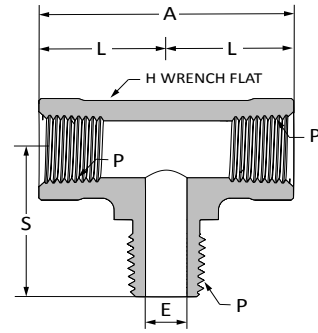

TruFit Part #	P Male & Female NPT Size	A	E Minimum Opening	H	L	S	316 SS Working Pressure	Brass Working Pressure
T2BT	1/8	1.32	0.19	9/16	0.66	0.78	9,250	3,250
T4BT	1/4	1.76	0.28	3/4	0.88	1.09	7,750	3,350
T6BT	3/8	2.04	0.40	7/8	1.02	1.22	6,800	2,650
T8BT	1/2	2.46	0.53	1 1/16	1.23	1.47	5,950	2,450
T12BT	3/4	2.27	0.71	1 3/8	1.36	1.59	5,600	-
T16BT	1	3.24	0.93	1 5/8	1.62	1.97	5,250	-
T20BT	1 1/4	3.40	1.25	2	1.70	2.38	6,200	-
T24BT	1 1/2	4.16	1.50	2 3/8	2.08	2.64	5,100	-
T32BT	2	4.78	1.94	2 7/8	2.39	3.00	4,000	-

MT: Male Tee

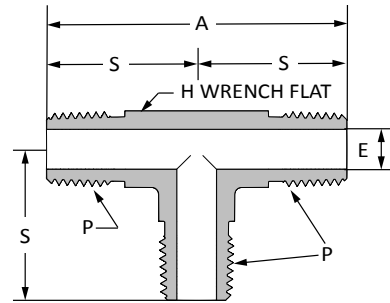
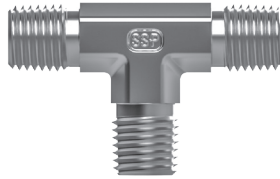

TruFit Part #	P Male NPT Size	A	E Minimum Opening	H	S	316 SS Working Pressure	Brass Working Pressure
T2MT	1/8	1.56	0.19	7/16	0.78	10,100	5,050
T4MT	1/4	2.18	0.28	9/16	1.09	8,300	4,050
T6MT	3/8	2.44	0.40	3/4	1.22	7,850	3,950
T8MT	1/2	2.94	0.53	7/8	1.47	7,750	3,850
T12MT	3/4	3.18	0.71	1 1/16	1.59	7,350	-
T16MT	1	3.94	0.93	1 5/16	1.97	5,500	-
TruFit 10K							
T4MT-10K	1/4	2.18	0.25	9/16	1.09	10,000	-
T6MT-10K	3/8	2.44	0.33	3/4	1.22	10,000	-
T8MT-10K	1/2	2.94	0.41	7/8	1.47	10,000	-

PCS: Pipe Cross

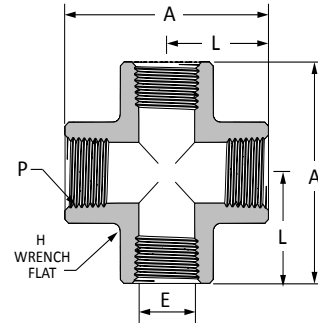

TruFit Part #	P Female NPT Size	A	E Minimum Opening	H	L	316 SS Working Pressure	Brass Working Pressure
T2PCS	1/8	1.32	0.34	9/16	0.66	9,250	3,250
T4PCS	1/4	1.76	0.45	3/4	0.88	7,750	3,350
T6PCS	3/8	2.04	0.59	7/8	1.02	6,800	2,650
T8PCS	1/2	2.46	0.73	1 1/16	1.23	5,950	2,450
T12PCS	3/4	2.72	0.94	1 5/16	1.36	5,600	2,350
T16PCS	1	3.24	1.17	1 5/8	1.62	5,250	2,250

E: Elbow

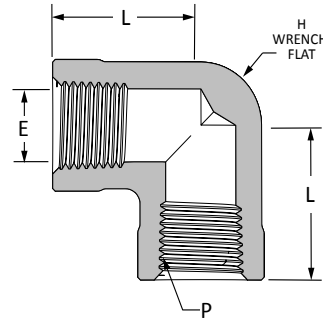

TruFit Part #	P Female NPT Size	E Minimum Opening	H	L	316 SS Working Pressure	Brass Working Pressure
T2E	1/8	0.34	9/16	0.66	9,250	3,250
T4E	1/4	0.45	3/4	0.88	7,750	3,350
T6E	3/8	0.59	7/8	1.02	6,800	2,650
T8E	1/2	0.73	1 1/16	1.23	5,950	2,450
T12E	3/4	0.94	1 5/16	1.36	5,600	2,350
T16E	1	1.17	1 5/8	1.62	5,250	2,250
T20E	1-1/4	1.47	1 7/8	1.70	1,800	-
T24E	1-1/2	1.69	2 1/2	2.08	4,550	-
T32E	2	2.16	2 7/8	2.39	3,050	-
TruFit 10K						
T2E-10K	1/8	0.33	3/4	0.66	10,000	-
T4E-10K	1/4	0.42	3/4	0.88	10,000	-
T6E-10K	3/8	0.56	1-1/16	1.02	10,000	-
T8E-10K	1/2	0.69	1-5/16	1.23	10,000	-

Dimensions are for reference only and are subject to change.

E45: 45° Elbow

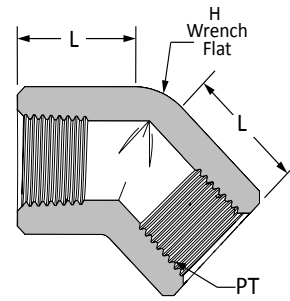

TruFit Part #	P Female NPT Size	E Minimum Opening	H	L	316 SS Working Pressure	Brass Working Pressure
T2E45	1/8	0.19	9/16	0.50	9,250	3,250
T4E45	1/4	0.28	3/4	0.69	7,750	3,350
T6E45	3/8	0.38	7/8	0.75	6,800	2,650
T8E45	1/2	0.47	1 1/16	0.94	5,950	2,450
T12E45	3/4	0.62	1 5/16	1.00	5,600	2,350
T16E45	1	0.88	1 5/8	1.19	5,250	2,250

ME: Male Elbow

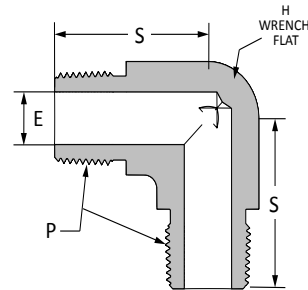
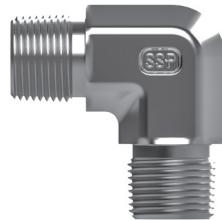

TruFit Part #	P Male NPT Size	E Minimum Opening	H	S	316 SS Working Pressure	Brass Working Pressure
T2ME	1/8	0.19	7/16	0.78	10,100	5,050
T4ME	1/4	0.28	9/16	1.09	8,300	4,050
T6ME	3/8	0.40	3/4	1.22	7,850	3,950
T8ME	1/2	0.53	7/8	1.47	7,750	3,850
T12ME	3/4	0.72	1 1/16	1.59	4,150	2,100
T16ME	1	0.94	1 5/8	1.57	3,800	1,500
TruFit 10K						
T4ME-10K	1/4	0.25	9/16	1.09	10,000	-
T6ME-10K	3/8	0.33	3/4	1.22	10,000	-
T8ME-10K	1/2	0.41	7/8	1.47	10,000	-

SE: Street Elbow

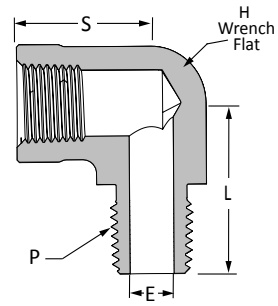

TruFit Part #	P Male & Female NPT Size	E Minimum Opening	H	L	S	316 SS Working Pressure	Brass Working Pressure
T1SE	1/16	0.12	9/16	0.50	0.72	9,600	3,350
T2SE	1/8	0.19	9/16	0.66	0.78	9,250	3,250
T4SE	1/4	0.28	3/4	0.88	1.09	7,750	3,350
T6SE	3/8	0.40	7/8	1.02	1.22	6,800	2,650
T8SE	1/2	0.53	1 1/16	1.23	1.47	5,950	2,450
T12SE	3/4	0.72	1 5/16	1.36	1.59	5,600	2,350
T16SE	1	0.93	1 5/8	1.62	1.97	5,250	2,250
T20SE	1 1/4	1.25	2	2.38	1.70	1,800	-
T24SE	1 1/2	1.50	2 3/8	2.64	2.08	2,800	-
T32SE	2	1.94	2 7/8	3.00	2.39	2,450	-
TruFit 10K							
T2SE-10K	1/8	4.8	3/4	0.98	0.66	10,000	-
T4SE-10K	1/4	6.3	3/4	1.09	0.88	10,000	-
T6SE-10K	3/8	8.3	1 1/16	1.22	1.02	10,000	-
T8SE-10K	1/2	10.4	1 5/16	1.47	1.23	10,000	-

RSE: Reducing Street Elbow

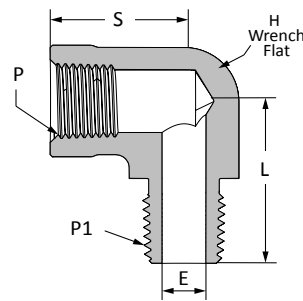

TruFit Part #	P Female NPT size	P1 Male NPT size	E Minimum Opening	H	L	S	316 SS Working Pressure	Brass Working Pressure
T2RSE1	1/8	1/16	0.12	9/16	0.91	0.88	6,550	3,250
T4RSE2	1/4	1/8	0.19	3/4	0.91	0.88	6,650	3,350
T6RSE4	3/8	1/4	0.28	7/8	1.22	1.02	5,350	2,650
T8RSE4	1/2	1/4	0.28	1 1/16	1.28	1.23	4,950	2,450
T8RSE6	1/2	3/8	0.38	1 1/16	1.28	1.23	4,950	2,450

Dimensions are for reference only and are subject to change.

SE45: 45° Street Elbow

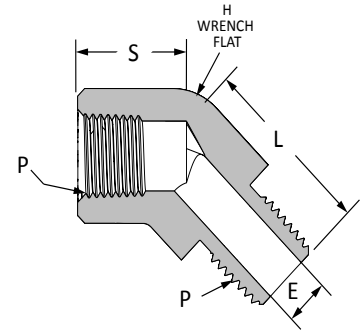
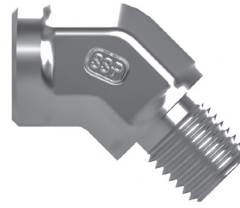

TruFit Part #	P Male & Female NPT Size	E Minimum Opening	H	L	S	316 SS Working Pressure	Brass Working Pressure
T2SE45	1/8	0.19	9/16	0.47	0.72	9,250	3,250
T4SE45	1/4	0.28	3/4	0.62	1.05	7,750	3,350
T6SE45	3/8	0.40	7/8	0.72	1.06	6,800	2,650
T8SE45	1/2	0.53	1 1/16	0.91	1.34	5,950	2,450
T12SE45	3/4	0.71	1 5/16	0.97	1.38	5,600	2,350
T16SE45	1	0.93	1 5/8	1.12	1.72	5,250	2,250
T20SE45	1 1/4	1.25	2	1.80	1.63	2,350	-
T24SE45	1 1/2	1.50	2 3/8	2.06	1.69	2,800	-

KUT: Female Pipe Union

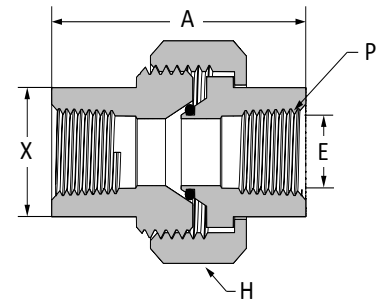
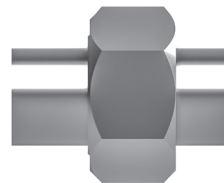

TruFit Part #	Pipe Size	P Female NPT Thread	A	E	H	X	Teflon Ring Size	316 SS Working Pressure
T2KUT	1/8	1/8	1.63	0.34	1 1/8	0.75	8TR	6,950
T4KUT	1/4	1/4	1.63	0.39	1 1/8	0.75	8TR	5,700
T6KUT	3/8	3/8	1.73	0.46	1 1/4	0.88	10TR	4,600
T8KUT	1/2	1/2	1.91	0.62	1 3/4	1.13	14TR	5,250
T12KUT	3/4	3/4	2.31	0.81	2	1.38	16TR	7,200
T16KUT	1	1	2.91	1.04	2 1/2	1.81	20TR	5,350
T20KUT	1 1/4	1 1/4	3.67	1.38	3	2.25	24TR	5,550
T24KUT	1 1/2	1 1/2	3.80	1.61	3 5/16	2.50	28TR	4,200
T32KUT	2	2	4.05	2.06	3 3/4	3.00	36TR	4,000

FST-MC: Female SAE x Male NPT

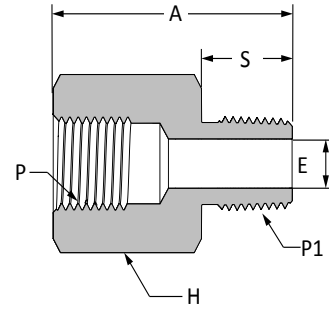
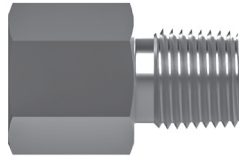

TruFit Part #	P Female SAE Thread	P1 Male NPT Thread	A	E	S	H	316 SS Working Pressure
T6FST4MC	9/16-18	1/4-18	1.36	0.28	0.56	13/16	5,400
T8FST6MC	3/4-16	3/8-18	1.49	0.41	0.56	1 1/16	5,400
T8FST8MC	3/4-16	1/2-14	1.58	0.53	0.75	1 1/16	5,400

FST-MST: Female SAE x Male SAE

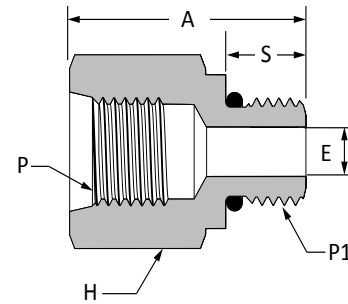
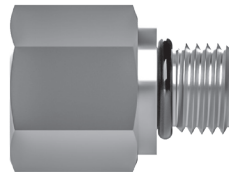

TruFit Part #	P Female SAE Thread	P1 Male SAE Thread	A	E	S	H	316 SS Working Pressure
T4FST4MST	7/16-20	7/16-20	1.06	0.20	0.36	11/16	5,400
T4FST6MST	7/16-20	9/16-18	1.16	0.20	0.36	13/16	5,400
T6FST6MST	9/16-18	9/16-18	1.19	0.30	0.39	13/16	5,400
T6FST8MST	9/16-18	3/4-16	1.38	0.30	0.39	1 1/16	4,800
T8FST6MST	3/4-16	9/16-18	1.06	0.42	0.44	7/8	5,400
T8FST8MST	3/4-16	3/4-16	1.47	0.42	0.44	1 1/16	4,800
T8FST10MST	3/4-16	7/8-14	1.56	0.42	0.44	1 1/8	3,600
T10FST8MST	7/8-14	3/4-16	1.31	0.50	0.50	1	4,800
T10FST12MST	7/8-14	1 1/16-12	1.69	0.50	0.50	1 3/8	4,200
T12FST10MST	1 1/16-12	7/8-14	1.44	0.66	0.59	1 1/4	3,600
T12FST16MST	1 1/16-12	1 5/16-12	1.88	0.66	0.59	1 5/8	2,400
T16FST12MST	1 5/16-12	1 1/16-12	1.75	0.88	0.59	1 1/2	4,200

MC-MST: Male NPT
x Male SAE

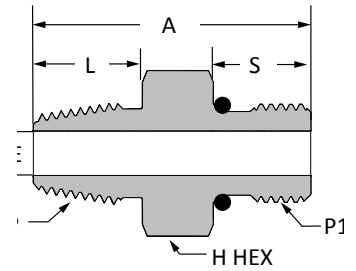
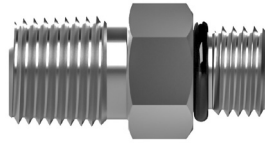

TruFit Part #	P1 Male NPT Thread	P Male SAE Thread	A	E	S	L	H	316 SS Working Pressure
T4MC4MST	1/4-18	7/16-20	1.24	0.20	0.56	0.36	9/16	6,000
T4MC6MST	1/4-18	9/16 - 18	1.30	0.28	0.56	0.36	11/16	6,000
T6MC6MST	3/8-18	9/16-18	1.30	0.30	0.56	0.39	11/16	6,000
T6MC8MST	3/8-18	3/4-16	1.37	0.41	0.56	0.39	7/8	6,000
T8MC8MST	1/2-14	3/4-16	1.56	0.42	0.75	0.44	7/8	6,000
T8MC10MST	1/2-14	7/8-14	1.69	0.50	0.75	0.44	1	4,800
T12MC12MST	3/4-14	1 1/16-12	1.75	0.66	0.75	0.59	1 1/4	4,800
T12MC16MST	3/4-14	1 5/16-12	1.89	0.72	0.75	0.59	1 1/2	3,600
T16MC16MST	1-11 1/2	1 5/16-12	1.90	0.84	0.94	0.59	1 1/2	3,600
TruFit 10K								
T4MC4MST-10K	1/4 - 18	7/16 - 20	1.24	0.19	0.57	0.36	5/8	10000
T4MC6MST-10K	1/4 - 18	9/16 - 18	1.30	0.19	0.57	0.39	11/16	10000
T6MC6MST-10K	3/8 - 18	9/16 - 18	1.30	0.26	0.57	0.39	11/16	10000
T6MC8MST-10K	3/8 - 18	3/4 - 16	1.37	0.36	0.57	0.44	7/8	10000
T8MC8MST-10K	1/2 - 14	3/4 - 16	1.56	0.36	0.76	0.44	7/8	10000
T8MC10MST-10K	1/2 - 14	3/4 - 16	1.59	0.42	0.76	0.50	1-1/8	10000
T12MC12MST-10K	3/4 - 14	1-1/16 - 12	1.75	0.51	0.76	0.59	1-1/4	10000
T12MC16MST-10K	3/4 - 14	1-5/16 - 12	1.89	0.67	0.76	0.59	1-1/2	10000
T16MC16MST-10K	1 - 11-1/2	1-5/16 - 12	1.90	0.67	0.95	0.59	1-1/2	10000

MST: Male SAE
x Male SAE

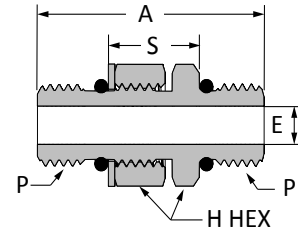
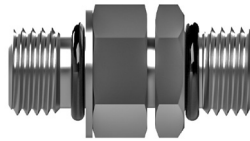

TruFit Part #	P Male SAE Thread	A	E	S	H	316 SS Working Pressure
T4MST	7/16-20	1.22	0.20	0.50	9/16	6,000
T6MST	9/16-18	1.04	0.30	0.59	11/16	6,000
T8MST	3/4-16	1.56	0.42	0.63	7/8	6,000
T10MST	7/8-14	1.81	0.48	0.75	1	5,400
T12MST	11/16-12	2.13	0.66	0.89	1 1/4	4,800
T16MST	1 5/16-12	2.13	0.88	0.89	1 1/2	3,600
T20MST	1 5/8-12	2.13	1.08	0.89	1 7/8	3,000
T24MST	1 7/8-12	2.13	1.34	0.89	2 1/8	2,400
T32MST	2 1/2-12	2.13	1.81	0.89	2 3/4	1,800

GP: Hex Plug, SAE

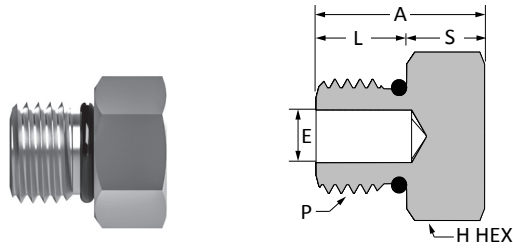

TruFit Part #	P Thread	A	E	S	L	H	316 SS Working Pressure
T2GP	5/16 - 24	0.60	0.09	0.28	0.30	7/16	7,200
T3GP	3/8 - 24	0.60	0.13	0.28	0.30	1/2	7,200
T4GP	7/16 - 20	0.67	0.20	0.28	0.36	9/16	7,200
T5GP	1/2 - 20	0.67	0.23	0.28	0.36	5/8	7,200
T6GP	9/16 - 18	0.73	0.30	0.31	0.39	11/16	7,200
T8GP	3/4 - 16	0.80	0.42	0.34	0.44	7/8	7,200
T10GP	7/8 - 14	0.93	0.50	0.41	0.50	1	7,200
T12GP	1-1/16 - 12	1.09	0.66	0.47	0.59	1 1/4	7,200
T16GP	1-5/16 - 12	1.12	0.88	0.50	0.59	1 1/2	6,600
T20GP	1-5/8 - 12	1.20	1.09	0.58	0.59	1 7/8	4,800
T24GP	1-7/8 - 12	1.27	1.34	0.65	0.59	2 1/8	3,600
T32GP	2-1/2 - 12	1.43	1.81	0.81	0.59	2 3/4	2,400

CGP: Plug, SAE Countersunk

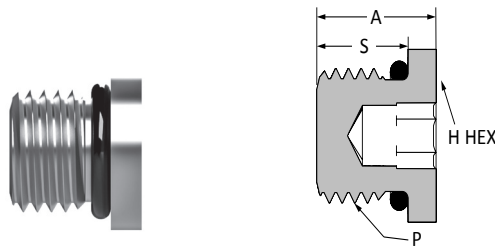

TruFit Part #	P Thread	A	S	H	316 SS Working Pressure
T2CGP	5/16-24	0.40	0.30	1/8	7200
T3CGP	3/8-24	0.40	0.30	1/8	7200
T4CGP	7/16-20	0.47	0.36	3/16	7200
T5CGP	1/2-20	0.47	0.36	3/16	7200
T6CGP	9/16-18	0.50	0.39	1/4	7200
T8CGP	3/4-16	0.58	0.44	5/16	7200
T10CGP	7/8-14	0.65	0.50	6/16	7200
T12CGP	1 1/16-12	0.77	0.59	9/16	7200
T16CGP	1 5/16-12	0.77	0.59	10/16	6600
T20CGP	1 5/8-12	0.77	0.59	3/4	4800
T24CGP	1 7/8-12	0.77	0.59	3/4	3600

TSMC: Tube Socket Weld x Male Connector

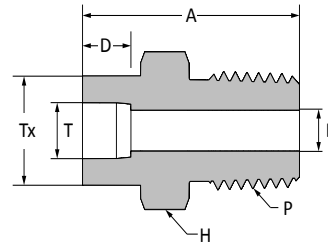
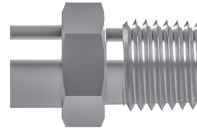

TruFit Part #	T Tube O.D.	P NPT Male Pipe	A	D	E	H	Tx	316 SS Working Pressure
T4TSMC4	1/4	1/4	1.12	0.25	0.19	5/8	0.50	8,000
T6TSMC4	3/8	1/4	1.25	0.34	0.28	5/8	0.60	8,000
T6TSMC6	3/8	3/8	1.31	0.34	0.28	3/4	0.63	7,800
T6TSMC8	3/8	1/2	1.50	0.34	0.37	7/8	0.63	7,700
T8TSMC4	1/2	1/4	1.44	0.40	0.28	13/16	0.79	6,600
T8TSMC6	1/2	3/8	1.31	0.38	0.37	3/4	0.73	6,600
T8TSMC8	1/2	1/2	1.66	0.41	0.43	7/8	0.81	6,600
T10TSMC8	5/8	1/2	1.63	0.47	0.50	15/16	0.92	6,700
T12TSMC12	3/4	3/4	1.69	0.50	0.66	1 1/8	1.11	6,700
T16TSMC16	1	1	2.00	0.56	0.91	1 3/8	1.36	6,100

TSFC: Tube Socket Weld Female Connector

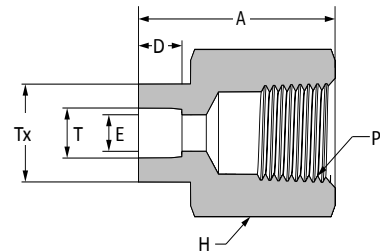
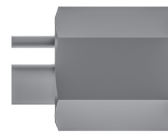

TruFit Part #	T Tube O.D.	P NPT Male Pipe	A	D	E	H	Tx	316 SS Working Pressure
T2TSFC2	1/8	1/8	0.88	0.20	0.09	9/16	0.38	6,500
T4TSFC2	1/4	1/8	0.97	0.25	0.19	9/16	0.50	6,500
T4TSFC4	1/4	1/4	1.13	0.25	0.19	3/4	0.50	6,600
T6TSFC4	3/8	1/4	1.22	0.34	0.31	3/4	0.63	6,600
T8TSFC6	1/2	3/8	1.41	0.40	0.43	7/8	0.81	5,300
T8TSFC8	1/2	1/2	1.63	0.40	0.43	1 1/8	0.81	4,900
T10TSFC8	5/8	1/2	1.63	0.47	0.50	1 1/8	0.94	4,600
T12TSFC12	3/4	3/4	1.78	0.50	0.66	1 3/8	1.13	4,600

TSU: Tube Socket Weld Union

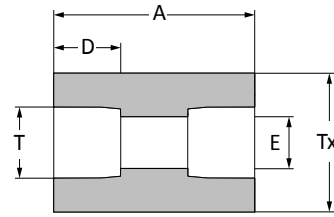

TruFit Part #	T Tube O.D.	A	D	E	Tx	316 SS Working Pressure
T4TSU	1/4	0.75	0.25	0.18	0.50	10,700
T6TSU	3/8	0.97	0.34	0.31	0.60	8,100
T8TSU	1/2	1.06	0.4	0.44	0.81	6,600
T10TSU	5/8	1.25	0.47	0.5	0.93	6,400
T12TSU	3/4	1.31	0.5	0.65	1.12	5,900
T16TSU	1	1.56	0.56	0.9	1.37	5,600

TSFE: Tube Socket Weld Female Elbow

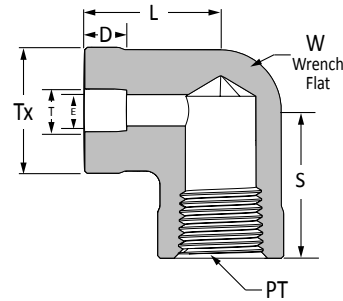

TruFit Part #	T Tube O.D.	P NPT Male Pipe	D	E	L	S	Tx	W	316 SS Working Pressure
T4TSFE4	1/4	1/4	0.25	0.19	0.81	0.90	0.50	3/4	7,400
T6TSFE4	3/8	1/4	0.34	0.31	0.91	0.88	0.63	7/8	7,400
T6TSFE8	3/8	1/2	0.40	0.31	1.03	1.23	0.63	1 1/16	5,700
T8TSFE8	1/2	1/2	0.41	0.44	1.13	1.23	0.81	1 1/16	5,700
T10TSFE8	5/8	1/2	0.47	0.50	1.16	1.23	0.94	1 1/16	5,600
T12TSFE12	3/4	3/4	0.50	0.66	1.44	1.36	1.13	1 5/16	4,600

TSME: Tube Socket
Weld Male Elbow

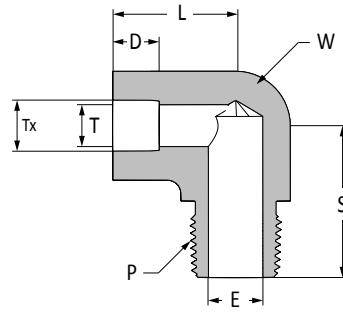

TruFit Part #	T Tube O.D.	P NPT Male Pipe	D	E	L	S	Tx	W	316 SS Working Pressure
T4SME4	1/4	1/4	0.25	0.28	0.66	1.09	0.50	1/2	8,000
T6TSME4	3/8	1/4	0.31	0.28	0.91	1.09	0.58	1/2	8,000
T6TSME6	3/8	3/8	0.34	0.41	0.93	1.24	0.63	11/16	7,800
T6TSME8	3/8	1/2	0.46	0.53	0.97	1.47	0.39	13/16	7,700
T8TSME8	1/2	1/2	0.40	0.53	1.08	1.49	0.81	13/16	6,600
T12TSME12	3/4	3/4	0.50	0.71	1.33	1.61	1.12	1	5,800

TSUE: Tube Socket
Weld Union Elbow

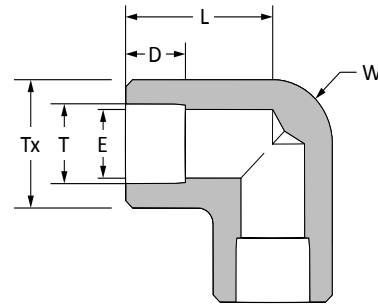

TruFit Part #	T Tube O.D.	D	E	L	Tx	W	Working Pressure
T4TSUE	1/4	0.25	0.18	0.69	0.49	7/16	10,700
T6TSUE	3/8	0.34	0.31	0.81	0.58	1/2	8,100
T8TSUE	1/2	0.40	0.44	1.02	0.78	3/4	6,600
T10TSUE	5/8	0.47	0.50	1.16	0.92	7/8	6,700
T12TSUE	3/4	0.50	0.65	1.31	1.12	1	5,900
T16TSUE	1	0.56	0.91	1.47	1.37	1 1/4	5,600

TSUT: Tube Socket
Weld Union Tee

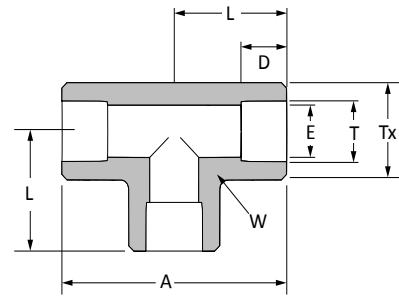

TruFit Part #	T Tube O.D.	A	D	E	L	Tx	W	316 SS Working Pressure
T2TSUT	1/8	1.26	0.20	0.09	0.63	0.38	7/16	12,600
T4TSUT	1/4	1.38	0.25	0.18	0.69	0.50	7/16	10,700
T6TSUT	3/8	1.62	0.34	0.31	0.81	0.63	9/16	8,100
T8TSUT	1/2	2.00	0.40	0.43	1.00	0.73	3/4	6,600
T10TSUT	5/8	2.30	0.46	0.50	1.16	0.88	7/8	6,700
T12TSUT	3/4	2.62	0.50	0.65	1.31	1.04	1-1/16	5,900
T16TSUT	1	2.94	0.56	0.90	1.47	1.44	1-5/16	5,600

TSUC: Tube Socket
Weld Union Cross

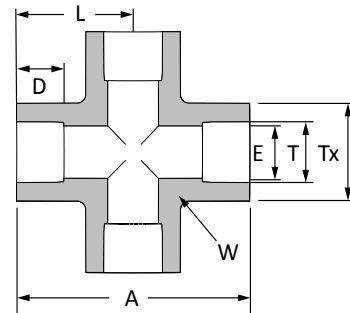

TruFit Part #	T Tube O.D.	A	D	E	L	Tx	W	316 SS Working Pressure
T2TSUC	1/8	1.26	0.20	0.09	0.63	0.38	7/16	11,000
T4TSUC	1/4	1.38	0.25	0.18	0.69	0.49	7/16	10,700
T6TSUC	3/8	1.62	0.34	0.31	0.81	0.58	9/16	8,100
T8TSUC	1/2	2.00	0.40	0.44	1.00	0.78	3/4	6,600
T12TSUC	3/4	2.62	0.50	0.65	1.31	1.16	1-1/16	5,900

MTTS: Male Tube Weld x
Tube Socket Weld

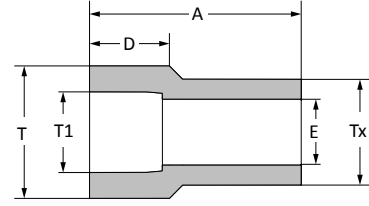

TruFit Part #	T Tube O.D.	T1 Tube Socket	A	D	E	Tx	316 SS Working Pressure
ISST4MTTS2	1/4	1/8	0.56	0.10	0.09	0.29	12,600
ISST6MTTS4	3/8	1/4	0.75	0.28	0.18	0.48	8,200
ISST8MTTS4	1/2	1/4	0.88	0.28	0.18	0.50	7,500
ISST8MTTS6	1/2	3/8	0.88	0.31	0.32	0.60	7,500
ISST12MTTS8	3/4	1/2	1.12	0.38	0.40	0.75	6,300
ISST16MTTS8	1	1/2	1.38	0.38	0.40	0.73	5,300

MPTS: Male Pipe Weld x
Tube Socket Weld

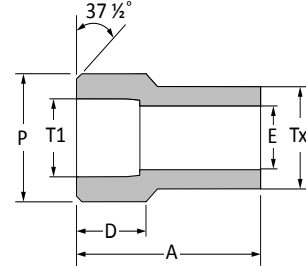

TruFit Part #	P Pipe Size	T1 Tube Socket	A	D	E	Tx	316 SS Working Pressure
ISST4MPTS4	1/4	1/4	0.88	0.28	0.18	0.48	9,600
ISST6MPTS6	3/8	3/8	1.03	0.31	0.28	0.60	7,600
ISST6MPTS8	3/8	1/2	1.00	0.38	0.42	0.73	6,200
ISST8MPTS4	1/2	1/4	1.12	0.28	0.18	0.48	7,300
ISST8MPTS6	1/2	3/8	1.12	0.31	0.28	0.60	7,300
ISST8MPTS8	1/2	1/2	1.19	0.38	0.40	0.73	6,200
ISST12MPTS6	3/4	3/8	1.50	0.31	0.28	0.60	6,200
ISST12MPTS8	3/4	1/2	1.50	0.38	0.40	0.73	6,200
ISST12MPTS12	3/4	3/4	1.50	0.44	0.62	1.05	5,700
ISST16MPTS6	1	3/8	1.38	0.31	0.28	0.60	5,600
ISST16MPTS8	1	1/2	1.56	0.38	0.40	0.73	5,600

AN-FC: 37° AN Female Connector

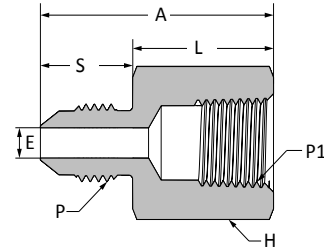
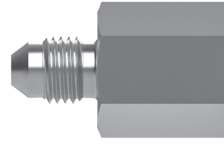

TruFit Part #	Tube O.D.	P Thread	P1 Female NPT Thread	A	E	S	L	H	316 SS Working Pressure	Brass Working Pressure
T2AN2FC	1/8	5/16	1/8	1.12	0.06	0.45	0.67	9/16	6,000	-
T4AN2FC	1/4	7/16	1/8	1.19	0.17	0.55	0.64	9/16	6,000	3,250
T4AN4FC	1/4	7/16	1/4	1.38	0.17	0.55	0.83	3/4	6,000	3,250
T5AN4FC	5/16	1/2	1/4	1.34	0.23	0.55	0.79	3/4	6,000	-
T6AN4FC	3/8	9/16	1/4	1.40	0.30	0.56	0.84	3/4	6,000	3,250
T6AN6FC	3/8	9/16	3/8	1.41	0.30	0.56	0.85	7/8	6,000	3,250
T8AN6FC	1/2	3/4	3/8	1.56	0.39	0.66	0.90	7/8	6,000	-
T8AN4FC	1/2	3/4	1/4	1.55	0.39	0.61	0.89	13/16	6,000	-
T8AN8FC	1/2	3/4	1/2	1.75	0.39	0.66	1.09	1-1/8	6,000	-
T10AN8FC	5/8	7/8	1/2	1.89	0.48	0.76	1.13	1-1/8	6,000	-
T12AN12FC	3/4	1 1/16	3/4	2.06	0.61	0.86	1.05	1-3/8	4,800	2,600
T12AN8FC	3/4	1 1/16	1/2	1.91	0.61	0.86	1.20	1-1/8	5,400	-
T16AN16FC	1	1 5/16	1	2.35	0.84	0.91	1.46	1-5/8	3,600	1,950
T20AN20FC	1 1/4	1 5/8	1-1/4	2.49	1.08	0.96	1.53	2	3,000	-
T24AN24FC	1 1/2	1 7/8	1-1/2	2.62	1.31	1.08	1.54	2-3/8	2,400	-
T32AN32FC	2	2 1/2	2	2.97	1.78	1.33	1.64	2-7/8	1,800	-

AN-MC: 37° AN x Male NPT

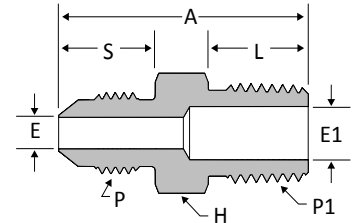
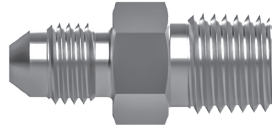

TruFit Part #	Tube O.D.	P Thread	P1 Female NPT Thread	A	E	E1	S	L	H	316 SS Working Pressure	Brass Working Pressure
T2AN2MC	1/8	5/16-24	1/8	1.11	0.06	0.19	0.45	0.38	7/16	6,000	-
T3AN2MC	3/16	3/8-24	1/8	1.14	0.13	0.19	0.48	0.38	7/16	6,000	-
T4AN2MC	1/4	7/16-20	1/8	1.22	0.17	0.17	0.55	0.38	1/2	6,000	3,250
T4AN4MC	1/4	7/16-20	1/4	1.42	0.17	0.17	0.55	0.56	9/16	6,000	3,250
T4AN6MC	1/4	7/16-20	3/8	1.44	0.17	0.17	0.55	0.56	3/4	6,000	-
T4AN8MC	1/4	7/16-20	1/2	1.69	0.17	0.17	0.55	0.75	7/8	6,000	-
T5AN2MC	5/16	1/2-20	1/8	1.22	0.23	0.19	0.55	0.38	9/16	6,000	-
T5AN4MC	5/16	1/2-20	1/4	1.42	0.23	0.23	0.55	0.56	9/16	6,000	-
T6AN2MC	3/8	9/16-18	1/8	1.24	0.30	0.19	0.56	0.38	5/8	6,000	-
T6AN4MC	3/8	9/16-18	1/4	1.43	0.30	0.28	0.56	0.56	5/8	6,000	3,250
T6AN6MC	3/8	9/16-18	3/8	1.44	0.30	0.30	0.56	0.56	3/4	6,000	3,250
T6AN8MC	3/8	9/16-18	1/2	1.69	0.30	0.30	0.56	0.75	7/8	6,000	-
T8AN4MC	1/2	3/4-16	1/4	1.53	0.39	0.19	0.66	0.56	13/16	6,000	-
T8AN6MC	1/2	3/4-16	3/8	1.53	0.39	0.39	0.66	0.56	13/16	6,000	3,250
T8AN8MC	1/2	3/4-16	1/2	1.78	0.39	0.39	0.66	0.75	7/8	6,000	3,250
T8AN12MC	1/2	3/4-16	3/4	1.85	0.39	0.39	0.66	0.75	1 1/8	4,800	-
T10AN8MC	5/8	7/8-14	1/2	1.89	0.48	0.48	0.76	0.75	15/16	6,000	-
T10AN12MC	5/8	7/8-14	3/4	1.95	0.48	0.48	0.76	0.75	1 1/8	4,800	-
T12AN8MC	3/4	1 1/16-12	1/2	2.06	0.61	0.53	0.86	0.75	1 1/8	5,400	-
T12AN12MC	3/4	1 1/16-12	3/4	2.06	0.61	0.61	0.86	0.75	1 1/8	4,800	2,600
T12AN16MC	3/4	1 1/16-12	1	2.25	0.61	0.61	0.86	0.94	1 3/8	3,600	-
T14AN12MC	7/8	1 3/16-12	3/4	2.09	0.72	0.72	0.86	0.75	1 1/4	4,200	-
T16AN12MC	1	1 5/16-12	3/4	2.11	0.84	0.72	0.91	0.75	1 3/8	4,200	-
T16AN16MC	1	1 5/16-12	1	2.30	0.84	0.84	0.91	0.94	1 3/8	3,600	1,950
T20AN20MC	1-1/4	1 5/8-12	1 1/4	2.45	1.08	1.08	0.96	0.97	1 11/16	3,000	-
T24AN24MC	1-1/2	1 7/8-12	1 1/2	2.68	1.31	1.31	1.08	1.00	2	2,400	-
T32AN32MC	2	2 1/2-12	2	3.11	1.78	1.78	1.33	1.03	2 5/8	1,800	-
TruFit 10K											
T2AN4MC-10K	1/8	5/16-24	1/4-18	1.32	0.06	0.25	0.45	0.57	9/16	10,000	-
T4AN4MC-10K	1/4	7/16-20	1/4-18	1.42	0.17	0.25	0.55	0.57	9/16	10,000	-
T4AN6MC-10K	1/4	7/16-20	3/8-18	1.42	0.17	0.17	0.55	0.57	3/4	10,000	-
T4AN8MC-10K	1/4	7/16-20	1/2-14	1.68	0.17	0.17	0.55	0.76	7/8	10,000	-
T6AN4MC-10K	3/8	9/16-18	1/4-18	1.43	0.26	0.25	0.56	0.57	5/8	10,000	-
T6AN6MC-10K	3/8	9/16-18	3/8-18	1.43	0.26	0.26	0.56	0.57	3/4	10,000	-
T6AN8MC-10K	3/8	9/16-18	1/2-14	1.69	0.26	0.41	0.56	.076	7/8	10,000	-
T8AN4MC-10K	1/2	3/4-16	1/4-18	1.53	0.36	0.25	0.66	0.57	13/16	10,000	-
T8AN6MC-10K	1/2	3/4-16	3/8-18	1.53	0.36	0.33	0.66	0.57	13/16	10,000	-
T8AN8MC-10K	1/2	3/4-16	1/2-14	1.79	0.36	0.36	0.66	0.76	7/8	10,000	-
T8AN12MC-10K	1/2	3/4-16	3/4-14	1.85	0.36	0.36	0.66	0.76	1-1/8	10,000	-
T12AN8MC-10K	3/4	1-1/16-12	1/2-14	2.06	0.52	0.41	0.86	0.76	1-1/8	10,000	-
T12AN12MC-10K	3/4	1-1/16-12	3/4-14	2.06	0.52	0.52	0.86	0.76	1-1/8	10,000	-
T16AN6MC-10K	1	1-5/16-12	3/8-18	1.92	0.67	0.33	0.91	0.57	1-3/8	10,000	-
T16AN8MC-10K	1	1-5/16-12	1/2-14	2.11	0.67	0.41	0.91	0.76	1-3/8	10,000	-
T16AN12MC-10K	1	1-5/16-12	3/4-14	2.11	0.67	0.52	0.91	0.76	1-3/8	10,000	-
T16AN16MC-10K	1	1-5/16-12	1	2.30	0.67	0.67	0.91	0.95	1-3/8	10,000	-

AN-MST: 37° AN x Male SAE

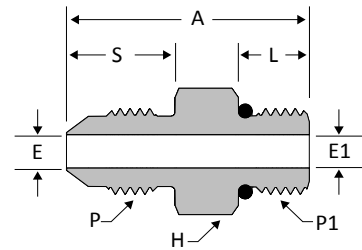
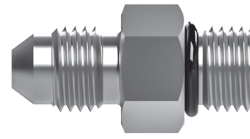

TruFit Part #	Tube O.D.	P Thread	P1 Male SAE Thread	A	E	E1	S	L	H	316 SS Working Pressure
T2AN2MST	1/8	5/16-24	5/16	1.06	0.06	0.06	0.45	0.30	7/16	6,000
T3AN3MST	3/16	3/8-24	3/8	1.10	0.13	0.13	0.48	0.30	1/2	6,000
T4AN4MST	1/4	7/16-20	7/16	1.23	0.17	0.17	0.55	0.36	9/16	6,000
T4AN5MST	1/4	7/16 - 20	1/2	1.23	0.17	0.23	0.55	0.36	5/8	6,000
T4AN6MST	1/4	7/16 - 20	9/16	1.29	0.17	0.30	0.55	0.39	11/16	6,000
T4AN8MST	1/4	7/16-20	3/4	1.37	0.17	0.39	0.55	0.44	7/8	6,000
T5AN5MST	5/16	1/2-20	1/2	1.23	0.23	0.23	0.55	0.36	5/8	6,000
T6AN6MST	3/8	9/16-18	9/16	1.30	0.30	0.30	0.56	0.36	11/16	6,000
T6AN4MST	3/8	9/16-18	7/16	1.29	0.30	0.17	0.56	0.36	5/8	6,000
T6AN8MST	3/8	9/16-18	3/4	1.38	0.30	0.39	0.56	0.44	7/8	6,000
T6AN10MST	3/8	9/16-18	7/8	1.50	0.30	0.48	0.56	0.50	1	6,000
T8AN8MST	1/2	3/4-16	3/4	1.48	0.39	0.39	0.66	0.44	7/8	6,000
T8AN6MST	1/2	3/4-16	9/16	1.38	0.39	0.30	0.66	0.39	13/16	6,000
T8AN10MST	1/2	3/4-16	7/8	1.60	0.39	0.48	0.66	0.50	1	6,000
T8AN12MST	1/2	3/4-16	1 1/16	1.76	0.39	0.61	0.66	0.59	1 1/4	6,000
T10AN8MST	5/8	7/8 - 14	3/4	1.60	0.48	0.39	0.76	0.44	15/16	6,000
T10AN10MST	5/8	7/8 - 14	7/8	1.70	0.48	0.48	0.76	0.50	1 1/4	6,000
T10AN12MST	5/8	7/8-14	1 1/16	1.86	0.48	0.61	0.76	0.56	1 1/4	6,000
T12AN8MST	3/4	1 1/16-12	3/4	1.76	0.61	0.39	0.86	0.44	1-1/8	6,000
T12AN10MST	3/4	1 1/16-12	7/8	1.86	0.61	0.48	0.86	0.50	1 1/8	6,000
T12AN12MST	3/4	1 1/16-12	1 1/16	1.97	0.61	0.61	0.86	0.56	1 1/4	6,000
T12AN14MST	3/4	1 1/16-12	1 3/16	1.96	0.61	0.61	0.86	0.59	1 3/8	5,400
T12AN16MST	3/4	1 1/16-12	1 5/16	1.99	0.61	0.84	0.86	0.59	1 1/2	5,400
T16AN16MST	1	1 5/16-12	1 5/16	2.04	0.84	0.84	0.91	0.59	1 1/2	5,400
T16AN12MST	1	1 5/16-12	1 1/16	1.99	0.84	0.61	0.91	0.59	1 3/8	5,400
T20AN20MST	1 1/4	1 5/8-12	1 5/8	2.17	1.08	1.08	0.96	0.59	1 7/8	3,600
T24AN24MST	1 1/2	1 7/8-12	1 7/8	2.37	1.31	1.31	1.00	0.59	2 1/8	2,400
T32AN32MST	2	2 1/2-12	2 1/2	2.78	1.78	1.78	1.03	0.59	2 3/4	1,800
TruFit 10K										
T4AN4MST-10K	1/4	7/16 - 20	7/16	1.23	0.17	0.17	0.55	0.36	9/16	10,000
T4AN6MST-10K	1/4	7/16 - 20	9/16	1.29	0.17	0.26	0.55	0.39	11/16	10,000
T6AN4MST-10K	3/8	9/16 - 18	7/16	1.27	0.26	0.17	0.56	0.36	5/8	10,000
T6AN6MST-10K	3/8	9/16 - 18	9/16	1.30	0.26	0.26	0.56	0.39	11/16	10,000
T8AN8MST-10K	1/2	3/4 - 16	3/4	1.48	0.36	0.36	0.66	0.44	7/8	10,000

Dimensions are for reference only and are subject to change.

FC-MRT: Female NPT x Male ISO Tapered

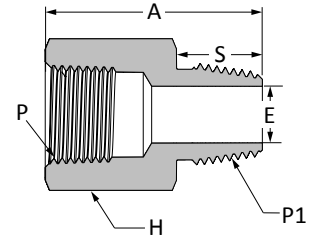
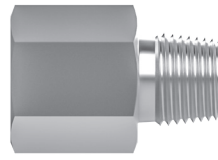

TruFit Part #	P Female NPT Thread	P1 Male ISO Tapered Thread	A	E Minimum Opening	S	H	316 SS Working Pressure	Brass Working Pressure
T2FC2MRT	1/8	1/8	1.04	0.19	0.38	5/8	6550	3250
T4FC4MRT	1/4	1/4	1.39	0.28	0.56	3/4	6650	3350
T6FC6MRT	3/8	3/8	1.44	0.41	0.56	7/8	5350	2650
T8FC8MRT	1/2	1/2	1.69	0.53	0.75	1 1/8	4950	2450
T12FC12MRT	3/4	3/4	1.93	0.72	0.75	1 3/8	4650	2350
T16FC16MRT	1	1	2.37	0.94	0.94	1 5/8	4450	2250
TruFit 10K								
T2FC2MRT-10K	1/8	1/8	1.04	0.17	0.38	5/8	10,000	-
T4FC4MRT-10K	1/4	1/4	1.39	0.24	0.56	3/4	10,000	-
T6FC6MRT-10K	3/8	3/8	1.44	0.32	0.56	7/8	10,000	-
T8FC8MRT-10K	1/2	1/2	1.69	0.40	0.75	1 1/8	10,000	-
T12FC12MRT-10K	3/4	3/4	1.93	0.53	0.75	1 3/8	10,000	-
T16FC16MRT-10K	1	1	2.37	0.67	0.94	1 5/8	10,000	-

MC-MRT: Male NPT x Male ISO Tapered

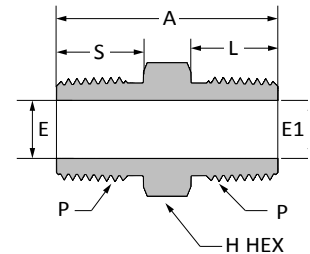
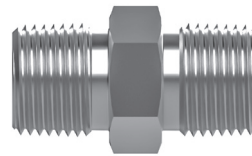

TruFit Part #	P Male NPT Thread	P1 Male ISO Tapered Thread	A	E Minimum Opening	E1	S	L	H	316 SS Working Pressure	Brass Working Pressure
T2MC2MRT	1/8	1/8	1.06	0.19	0.19	0.38	0.38	7/16	10,050	5,050
T4MC4MRT	1/4	1/4	1.45	0.28	0.19	0.56	0.56	5/8	8,050	4,050
T6MC6MRT	3/8	3/8	1.45	0.41	0.41	0.56	0.56	3/4	7,850	3,950
T8MC8MRT	1/2	1/2	1.89	0.53	0.53	0.75	0.75	7/8	7,750	3,850
T12MC12MRT	3/4	3/4	1.96	0.72	0.28	0.75	0.75	1 1/8	7,350	3,650
T16MC16MRT	1	1	2.34	0.94	0.94	0.94	0.94	1 3/8	5,350	2,650
TruFit 10K										
T2MC2MRT-10K	1/8-27	1/8-28	1.06	0.19	0.17	0.38	0.38	7/16	10,000	-
T4MC4MRT-10K	1/4-18	1/4-19	1.45	0.24	0.24	0.57	0.56	5/8	10,000	-
T6MC6MRT-10K	3/8-18	3/8-19	1.45	0.32	0.32	0.57	0.56	3/4	10,000	-
T8MC8MRT-10K	1/2-14	1/2-14	1.89	0.40	0.40	0.76	0.75	7/8	10,000	-
T12MC12MRT-10K	3/4-14	3/4-14	1.96	0.51	0.53	0.76	0.75	1-1/8	10,000	-
T16MC16MRT-10K	1 11-1/2	1-11	2.34	0.67	0.67	0.95	0.94	1-3/8	10,000	-

MC-MRS: Male NPT x Male ISO Straight

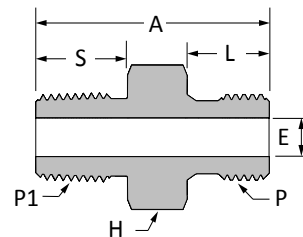
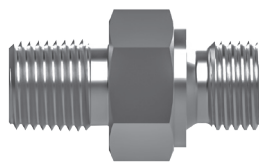

TruFit Part #	P1 Male NPT Thread	P Male ISO Straight Thread	A	E	S	L	H	316 SS Working Pressure
T2MC2MRS	1/8	1/8	1.07	0.16	0.38	0.28	9/16	11,400
T4MC4MRS	1/4	1/4	1.37	0.23	0.57	0.45	3/4	6,000
T6MC6MRS	3/8	3/8	1.37	0.3	0.57	0.45	7/8	6,000
T8MC8MRS	1/2	1/2	1.74	0.48	0.76	0.56	1 1/8	6,000
T12MC12MRS	3/4	3/4	1.89	0.66	0.73	0.56	1 3/8	4,800
T16MC16MRS	1	1	2.27	0.84	0.95	0.73	1 3/4	3,600
TruFit 10K								
T2MC2MRS-10K	1/8-28	1/8	1.09	0.17	0.39	0.28	9/16	10,000
T2MC4MRS-10K	1/4-19	1/8	1.25	0.17	0.39	0.44	3/4	10,000
T4MC2MRS-10K	1/8-28	1/4	1.27	0.17	0.57	0.28	9/16	10,000
T4MC4MRS-10K	1/4-19	1/4	1.45	0.23	0.57	0.44	3/4	10,000
T4MC6MRS-10K	3/8-19	1/4	1.48	0.25	0.57	0.44	7/8	10,000
T4MC8MRS-10K	1/2-14	1/4	1.58	0.23	0.57	0.56	1-1/16	10,000
T6MC4MRS-10K	1/4-19	3/8	1.47	0.23	0.57	0.44	3/4	10,000
T6MC6MRS-10K	3/8-19	3/8	1.48	0.32	0.57	0.44	7/8	10,000
T6MC8MRS-10K	1/2-14	3/8	1.56	0.32	0.57	0.56	1-1/16	10,000
T8MC4MRS-10K	1/4-19	1/2	1.62	0.23	0.76	0.44	7/8	10,000
T8MC6MRS-10K	3/8-19	1/2	1.67	0.32	0.76	0.44	7/8	10,000
T8MC8MRS-10K	1/2-14	1/2	1.45	0.40	0.76	0.56	1-1/16	10,000
T8MC10MRS-10K	5/8-14	1/2	1.75	0.41	0.76	0.56	1-5/16	10,000
T8MC12MRS-10K	3/4-14	1/2	1.83	0.41	0.76	0.62	1-5/16	10,000
T12MC8MRS-10K	1/2-14	3/4	1.82	0.53	0.76	0.56	1-1/8	10,000
T12MC12MRS-10K	3/4-14	3/4	1.93	0.53	0.76	0.62	1-5/16	10,000
T12MC16MRS-10K	1-11	3/4	2.03	0.53	0.76	0.72	1-5/8	10,000
T16MC8MRS-10K	1/2-14	1	2.05	0.47	0.95	0.56	1-3/8	10,000
T16MC12MRS-10K	3/4-14	1	2.13	0.53	0.95	0.62	1-3/8	10,000
T16MC16MRS-10K	1-11	1	2.23	0.67	0.95	0.72	1-5/8	10,000
T16MC20MRS-10K	1-1/4-11	1	2.25	0.67	0.95	0.73	2	10,000

DW-BSPP: Bonded Washer

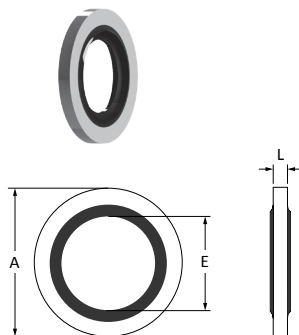

TruFit Part #	A	E	L
4DW-BSPP	0.81	0.54	0.08
6DW-BSPP	0.94	0.68	0.08
8DW-BSPP	1.13	0.85	0.10
12DW-BSPP	1.38	1.06	0.10
16DW-BSPP	1.69	1.33	0.10

* Bonded washer comes standard as a stainless steel washer with FKM inner ring.

FC-MRS: Female NPT x Male ISO Straight

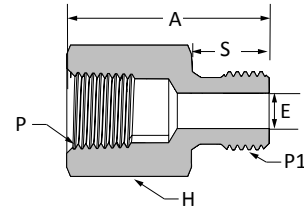
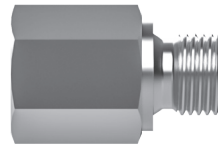

TruFit Part #	P Female NPT Thread	P1 Male ISO Straight Thread	A	E	S	H	316 SS Working Pressure
T2FC2MRS	1/8	1/8	1.33	0.23	0.45	3/4	6,500
T4FC4MRS	1/4	1/4	1.33	0.23	0.45	3/4	6,000
T6FC6MRS	3/8	3/8	1.33	0.30	0.45	7/8	6,000
T8FC8MRS	1/2	1/2	1.70	0.48	0.56	1-1/8	6,000
T12FC12MRS	3/4	3/4	1.82	0.66	0.56	1-3/8	4,200
T16FC16MRS	1	1	1.93	0.84	0.73	1-3/4	3,600

FRS-MC: Female ISO Straight x Male NPT

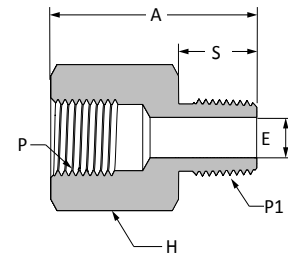
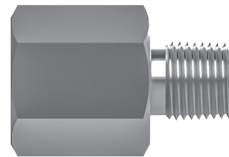

TruFit Part #	P Female ISO Straight Thread	P1 Male NPT Thread	A	E	S	H	316 SS Working Pressure
T4FRS4MC	1/4	1/4	1.42	0.28	0.57	3/4	7,200
T6FRS6MC	3/8	3/8	1.47	0.41	0.57	7/8	7,200
T8FRS8MC	1/2	1/2	1.89	0.53	0.76	1 1/8	6,000
TruFit 10K							
T4FRS4MC-10K	1/4	1/4	1.50	0.24	0.57	13/16	10,000
T6FRS6MC-10K	3/8	3/8	1.54	0.32	0.57	1	10,000
T8FRS8MC-10K	1/2	1/2	1.88	0.40	0.76	1-1/4	10,000



More SSP Products



Tube Fittings

Duolok and Griplok two-ferrule and Unilok® single ferrule tube fittings provide leak-tight installation even when intermixed with Swagelok®, Hoke Gyrolok® and Parker CPI™ fittings.



Valves

The SSP valve offering includes ball, check, metering, needle, toggle, plug, bleed, and purge valves for pressures up to 10,000 psig.



Tubing

SSP offers straight and coiled seamless 316 stainless steel instrumentation tubing for instrumentation, process and utility applications.



Pipe Fittings

TruFit and TruFit 10K pipe fittings are available in a wide range of weld, threaded and flared connections.



Filters

SSP in-line and tee-type filters trap particles to clean sample fluids and protect sensitive process and analytical instrumentation components and equipment.



Tools & Accessories

SSP TurnPro professional hand tools, power tools and installation training make quality tube system installation faster and easier.



Quick Connects

SSP offers single-end shutoff, double-end shutoff, and full-flow quick connects for instrumentation and process applications.



SSP

Founded 1926

Privately owned, third generation business

Modern single-site vertically integrated manufacturing facility

DFARS-compliant raw material

ISO 9001 quality management system

Limited Lifetime Warranty



*The Only
100% American Made
Instrument Valves & Fittings*

8250 Boyle Parkway • Twinsburg, OH 44087

330-425-4250 • www.mySSP.com

©2024 SSP Fittings Corp. All rights reserved.

TFPC-24A